



Catalog SM05EN

# Stepper Products

## Motors

## Drives

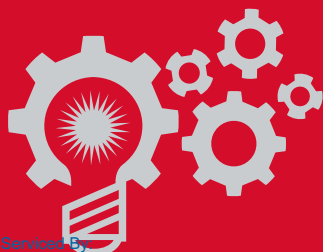

- TorquePower Series
- TorquePower Plus Series
- TorquePower Enhanced Series

- SA-Series
- PRO Series

Sold & Serviced By  
**ELECTROMATE**

Toll Free Phone (877) SERV008

Toll Free Fax (877) SERV009

[www.electromate.com](http://www.electromate.com)

[sales@electromate.com](mailto:sales@electromate.com)



For over 60 years, ElectroCraft has been helping engineers translate innovative ideas into reality – one reliable motor at a time. As a global specialist in custom motor and motion technology, we provide the engineering capabilities and worldwide resources you need to succeed.



This guide has been developed as a quick reference tool for ElectroCraft products. It is not intended to replace technical documentation or proper use of standards and codes in installation of product.

Because of the variety of uses for the products described in this publication, those responsible for the application and use of this product must satisfy themselves that all necessary steps have been taken to ensure that each application and use meets all performance and safety requirements, including all applicable laws, regulations, codes and standards.

Reproduction of the contents of this copyrighted publication, in whole or in part without written permission of ElectroCraft is prohibited.

Designed by media & brands · [www.media-brands.de](http://www.media-brands.de)



## Table of Contents

Typical Applications . . . . . 3  
 Which Stepper Motor . . . . . 5  
 TPP & v TPE Drive Product Matrix . . . . . 6

**TorquePower Series** . . . . . 7  
 TP23 . . . . . 7  
 TP34 . . . . . 9  
 TP42 . . . . . 11



TP

**TorquePower Plus Series** . . . . . 13  
 TPP11 . . . . . 13  
 TPP17 . . . . . 15  
 TPP23 . . . . . 17  
 TPP34 . . . . . 19



TPP

**TorquePower Enhanced Series** . . . . . 21  
 TPE17 . . . . . 21



TPE

**SA-Series** . . . . . 25  
 SA45 . . . . . 25



SA

**PRO Series** . . . . . 27  
 PRO-A04V36 . . . . . 29  
 PRO-A08V48 . . . . . 31



PRO

Connection Diagrams . . . . . 33  
 System Matrix . . . . . 36  
 Other Products . . . . . 37  
 Drives Accessories . . . . . 40



## Typical applications for ElectroCraft Stepper Motors:

- Custom OEM applications  
(Our Specialty)
- Packaging
- Semiconductor handling and testing
- Antenna positioning
- Laboratory equipment
- Rapid prototyping machines
- Medical equipment
- Dispensing



### Dialysis Machine

**Situation:** A next generation kidney dialysis machine was being designed with two modifications to the original stepper motor used for the blood pump due to problematic issues during operation. The first design challenge was the mechanism that coupled the motor shaft to the machine was a cause of long-term failure due to stress caused by point loading. The second challenge was the noise inherent to stepper motor operation was bothersome to patients who were connected to the machine for hours at a time.

**Solution:** The motor shaft was designed and machined such that it mated directly to the pump by customizing the shaft diameter, tapping a concentric threaded hole, providing a thru-hole for set-screw and incorporating a ridge for an O-ring seal. The rotor was designed to eliminate the detent torque by skewing the normally straight laminations on the teeth. This patented design provides reduced vibration and noise from the motor when operated in all full, half and micro-stepping resolutions.

**Results:** Working with the ElectroCraft engineering team, the medical machine manufacturer was able to resolve several problems in their original machine design with an updated design that better integrated the motor into the machine improving both the reliability and the patient experience.



*A redesigned motor from ElectroCraft improved both machine reliability and the patient experience*

## Industrial Surveillance Equipment

**Situation:** A manufacturer of outdoor pan-and-tilt surveillance cameras experienced a problem with their newly-designed system. The stock stepper motors they had integrated into their design kept breaking at the shaft, and their motor vendor could not remedy the issue.

**Solution:** ElectroCraft created a stepper with a larger, more rugged shaft that could be retrofit into the customer's products already in the field. The custom stepper motors were built into the newer models to maintain long-term product durability.

**Results:** Over 1000 surveillance systems have shipped with the custom stepper motor system installed. Since the stepper switch, not one stepper motor shaft failure has been reported.



*Custom rock-solid steppers gave surveillance cameras the added security of long life.*

## Medical Diagnostic Imaging Equipment

**Situation:** A medical diagnostic imaging machine manufacturer kept experiencing stepper motor failures in its imaging machines, and customers of their higher-priced units were complaining about reliability.

**Solution:** ElectroCraft built a fully customized, compact and ultra-rugged stepper that would fit more securely into the imager. The new motor included a custom-designed housing, shaped to fit into the machine itself.

**Results:** By working with ElectroCraft's engineering team to integrate in the new system, the company cut their anticipated time to market by one quarter. In addition, the new motor integration prompted a successful product marketing launch and helped the manufacturer gain significant market share.



*A fully-customized, ultra-rugged stepper became the heart of a new, market-leading line of medical diagnostic image machines.*



Select your  
**Stepper Products!**



## ElectroCraft TorquePower™

Sizes: Nema 23, 34 & 42

Torque: up to 2100 oz-in or 1482 Ncm

- Features:
- Conventional stepper
  - Environmentally sealed
  - Imperial sizes
  - Housed motor reduces radiated magnetic flux
  - High step accuracy

## ElectroCraft TorquePower™ Plus

Sizes: Nema 11, 17, 23 & 34

Torque: up to 1190 oz-in or 840 Ncm

- Features:
- High torque stepper
  - High performing
  - Metric and imperial sizes
  - High step accuracy

## ElectroCraft TorquePower™ Enhanced Series

Sizes: Nema 17

Torque: up to 78 oz-in or 55 Ncm

- Features:
- Highest performing
  - Metric and imperial sizes

## TPP & TPE Drive Product Matrix

	Bipolar Stepper Drive			
	ElectroCraft CompletePower™		ElectroCraft PRO Series	
	SA4505	SA4510	PRO-A04V36	PRO-A08V48
<b>Product Description</b>				
See on page	25	25	29	31
<b>Power Features</b>				
Min. Voltage (VDC)	11	11	11	11
Max. Voltage (VDC)	48	48	36	48
Dual Bridge MOSFET Driver	●	●	●	●
Chopping Frequency (kHz)	50 kHz	50 kHz	up to 60	up to 60
<b>Power Ratings</b>				
Nominal Current	3.5	7.1	2.8	5.7
Adjustable Current	●	●	●	●
Max Power (W)	240	480	144	385
<b>Control Modes</b>				
Max. Step Input Frequency	40 kHz	40 kHz		
Microstepping up to 1/16	●	●		
Internal Oscillator	●	●		
External Pulse Train (5-24 Logic)	●	●		
Fallback Current	●	●		
Analog Command (VDC)	1-5	1-5	0-5	0-5
Torque Control			●	●
Speed Control	●	●	●	●
Position Control			●	●
Fully Programmable Instruction Set			●	●
<b>Communication / Compliance</b>				
CE Compliance (LV Directive)	●	●	●	●
Optically Isolated Control Logic	●	●	●	●
Programmable I/O			●	●
CAN-Bus 2.0B / CANopen			●	●
<b>Physical Enclosure</b>				
Totally Enclosed	●	●	●	●
Case Type	Book Shelf	Book Shelf	Book Shelf	Book Shelf



*Still need help?*  
 Easily build your own motor at  
[www.configureamotor.com](http://www.configureamotor.com)



*Don't see exactly what you need?*  
 Have ElectroCraft build you a custom winding, stack length or fully customized motor... that's our specialty!

## TP23 : ElectroCraft TorquePower™ | Stepper Motor

Size	Holding Torque oz-in (Ncm)	Speeds up to RPS
Nema 23, 1.8°	210 (148)	85



### Forceful. Extra-sturdy.

This 1.8° size 23 hybrid DC stepping motor is built with an extra-sturdy casing for when you need small, powerful torque with a little more durability. The motor is totally enclosed with permanently lubricated ball bearings. The bi-directional size 23 has a step angle accuracy of ±3%.

### To build your own motor, choose the:

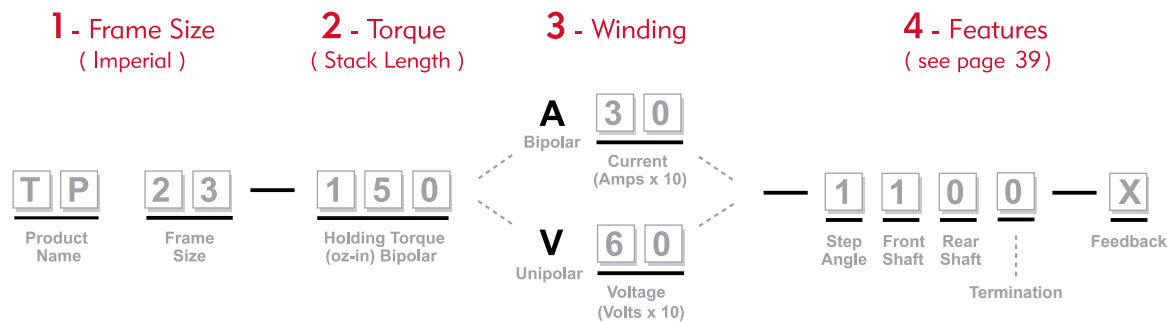

### Step 1: TP23 Frame Size Drawing Key

Bipolar Model	Unipolar Model	MAX Length	A	B	C	D	E	F	G	H	I	J
			Front Shaft Diameter	Front Shaft Length	Pilot Diameter	Pilot Length (Ref)	Mount Hole Callout	Mount Hole Spacing (Ref)	Flange External Dimension (Ref)	Rear Shaft Diameter	Rear Shaft Length	Encoder Length (max)
TP23-48	TP23-38	1.60 in ±.03	0.2500 in 0.2495 in	0.81 in ±0.03	1.502 in 1.498 in	0.06 in	[4] 0.205 in ±.010 Through	1.86 in	2.25 in	0.2500 in 0.2495 in	0.75 in ±0.040	0.70 in
TP23-72	TP23-57	2.00 in ±.03										
TP23-150	TP23-120	3.00 in ±.03										
TP23-210	TP23-168	4.00 in ±.03										

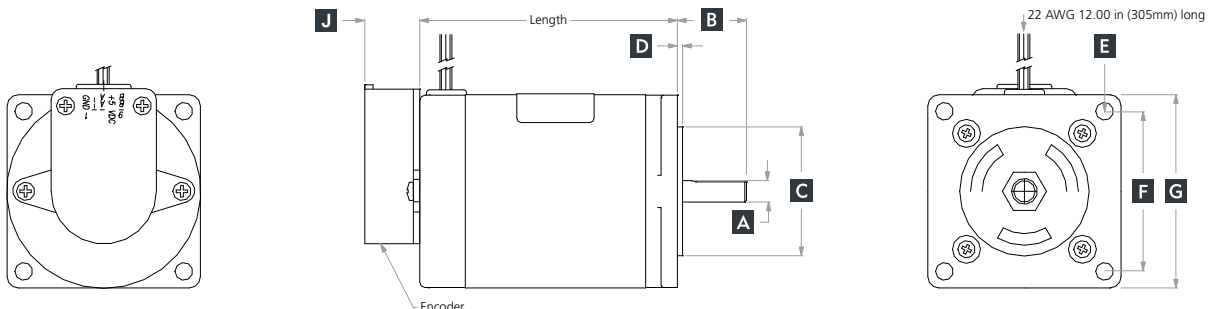



**Step 2: TP23 Torque and Mechanical Data**

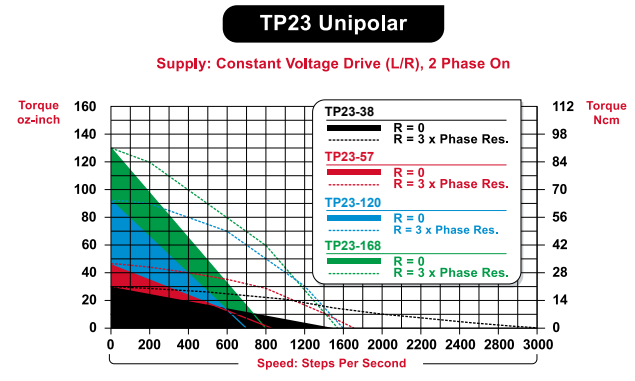
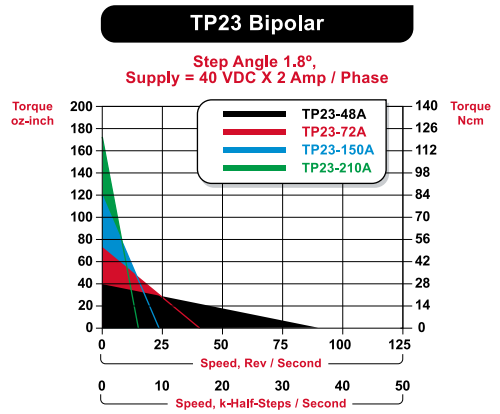

Stack Size Models	Bipolar				Unipolar			
	48A	72A	150A	210A	38V	57V	120V	168V
Holding Torque oz-in (Ncm)	48.0 (33.89)	72.0 (50.84)	150.0 (105.92)	210.0 (148.28)	38.5 (27.2)	57.5 (40.66)	120.0 (84.7)	168.0 (118.6)
Step Angle (°/step)	1.8°	1.8°	1.8°	1.8°	1.8°	1.8°	1.8°	1.8°
Rotor Inertia (oz-in-sec <sup>2</sup> )	0.00081	0.00166	0.00331	0.00497	0.00081	0.00166	0.00331	0.00497
Weight oz (g)	14 (397)	19 (539)	32 (907)	47 (1332)	14 (397)	19 (539)	32 (907)	47 (1332)

**Step 3: Available Windings**

Bipolar															
Imperial	48A10	48A20	48A30	48A40	72A10	72A20	72A30	72A40	150A10	150A20	150A30	150A40	210A20	210A30	210A40
Current Bipolar (A/Phase)	1.0	2.0	3.0	4.0	1.0	2.0	3.0	4.0	1.0	2.0	3.0	4.0	2.0	3.0	4.0
Phase Resistance (ohm)	5.9	1.5	0.66	0.37	5.6	1.4	0.62	0.35	7.6	1.9	0.84	0.48	2.65	1.18	0.66
Phase Inductance (mH)	16.9	4.2	1.9	1.11	25.6	6.4	2.8	1.6	35.2	8.8	3.9	2.2	13.2	5.88	3.33
Unipolar															
Imperial	38V40	38V60	38V120	38V240	57V51	57V60	57V120	57V240	120V54	120V60	120V120	120V240	168V34	168V60	168V120
Unipolar (V/Phase)	4.0	6.0	12.0	24.0	5.1	6.0	12.0	24.0	5.4	6.0	12.0	24.0	3.4	6.0	12.0
Unipolar (A/Phase)	1.5	1.2	0.6	0.3	1.0	1.0	0.5	0.3	1.5	1.3	0.7	0.4	2.8	1.8	0.8
Phase Resistance (ohm)	2.6	5	20	80	5.1	6.2	25	96	3.5	4.8	18.2	66	1.2	3.4	16
Phase Inductance (mH)	3.2	5.4	21.6	81.2	9.7	10.6	41.19	131.4	7.8	11.4	41.2	143.3	2.9	8.4	39
Bipolar (A/Phase)*	1.1	0.9	0.4	0.2	0.7	0.7	0.3	0.2	1.1	0.9	0.5	0.3	2.0	1.3	0.5

TP

## TP34 : ElectroCraft TorquePower™ | Stepper Motor

Size	Holding Torque oz-in (Ncm)	Speeds up to RPS
Nema 34, 1.8°	620 (438)	55



### Forceful. Extra-sturdy.

This 1.8° size 34 hybrid DC stepping motor is built with an extra-sturdy casing for when you need medium-sized, powerful torque with a little more durability. The motor is totally enclosed with permanently lubricated ball bearings. The bi-directional size 34 has a step angle accuracy of ±3%.

### To build your own motor, choose the:

**1 - Frame Size**  
( Imperial )

**2 - Torque**  
( Stack Length )

**3 - Winding**

**4 - Features**  
( see page 39 )

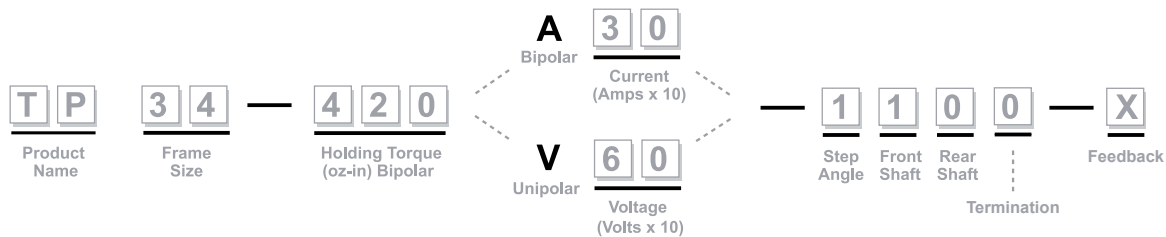

### Step 1:

### TP34 Frame Size Drawing Key

Bipolar Model	Unipolar Model	MAX Length	A	B	C	D	E	F	G	H	I	J
			Front Shaft Diameter	Front Shaft Length	Pilot Diameter	Pilot Length (Ref)	Mount Hole Callout	Mount Hole Spacing (Ref)	Flange External Dimension (Ref)	Rear Shaft Diameter	Rear Shaft Length	Encoder Length (max)
TP34-235	TP34-188	2.45 in ±.03	0.3750 in 0.3745 in	1.19 in ±.03	2.877 in 2.873 in	0.06 in	[4] 0.22 in ±.010 Through	2.74 in	3.25 in	0.3750 in 0.3745 in	1.19 in ±.04	0.70 in
TP34-420	TP34-336	3.70 in ±.03										
TP34-620	TP34-496	5.08 in ±.03										

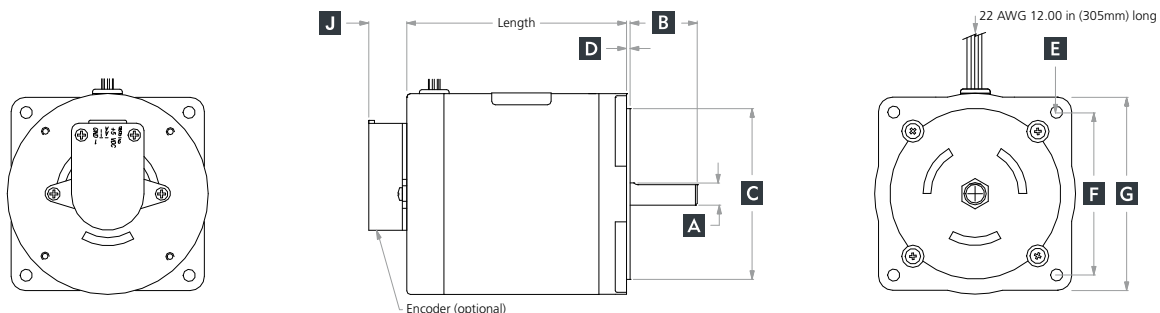

**Step 2: TP34 Torque and Mechanical Data**

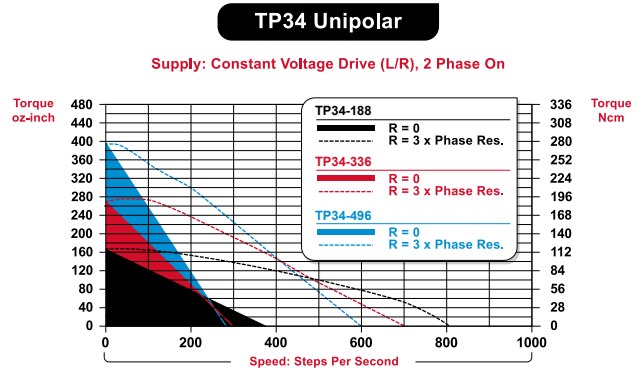
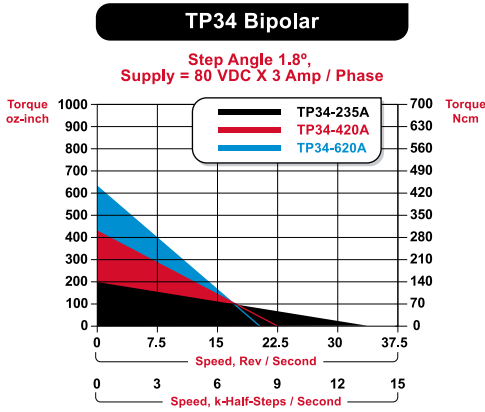

Stack Size Models	Bipolar			Unipolar		
	235A	420A	620A	188V	336V	496V
Holding Torque oz-in (Ncm)	235.0 (165.93)	420.0 (296.56)	620.0 (437.78)	188.0 (133)	336.0 (237)	496.0 (350)
Step Angle (°/step)	1.8°	1.8°	1.8°	1.8°	1.8°	1.8°
Rotor Inertia (oz-in-sec <sup>2</sup> )	0.0091	0.017	0.0265	0.0091	0.017	0.0265
Weight oz (g)	48 (1361)	80 (2268)	121 (3430)	48 (1361)	80 (2268)	121 (3430)

**Step 3: Available Windings**

Bipolar													
Imperial	235A20	235A30	235A40	235A60	420A20	420A30	420A40	420A60	620A20	620A30	620A40	620A60	
Current Bipolar (A/Phase)	2.0	3.0	4.0	6.0	2.0	3.0	4.0	6.0	2.0	3.0	4.0	6.0	
Phase Resistance (ohm)	2.2	0.96	0.55	0.24	3	1.33	0.75	0.33	3.8	1.7	0.96	0.43	
Phase Inductance (mH)	20.4	9.07	5.1	2.27	33.2	14.8	8.3	3.7	54.5	24.2	13.6	6.1	
Unipolar													
Imperial	188V26	188V53	188V120	188V240	336V25	336V30	336V60	336V120	336V240	496V22	496V43	496V120	496V240
Unipolar (V/Phase)	2.6	5.3	12.0	24.0	2.5	3.0	6.0	12.0	24.0	2.2	4.3	12.0	24.0
Unipolar (A/Phase)	3.1	1.6	0.7	0.3	4.6	4.0	2.0	1.0	0.6	7.1	3.6	1.2	0.6
Phase Resistance (ohm)	0.85	3.3	18	72	0.55	0.75	3	11.5	44	0.31	1.2	10.3	41
Phase Inductance (mH)	4.15	17.5	80	315	2.75	3.6	16.45	64.2	237	1.81	7.65	60	249
Bipolar (A/Phase)*	2.2	1.1	0.5	0.2	3.2	2.8	1.4	0.7	0.4	5.0	2.5	0.8	0.4

TP

## TP42 : ElectroCraft TorquePower™ | Stepper Motor

Size	Holding Torque oz-in (Ncm)	Speeds up to RPS
Nema 42, 1.8°	2100 (1480)	24



### Protected. Force.

If you need a corrosion-resistant motor with powerful force, this 1.8° size 42 hybrid DC stepping motor could be for you. It is totally enclosed with permanently lubricated ball bearings. The bi-directional size 42 has holding torque up to 2100 oz-in with a step angle accuracy of ±3% non-cumulative.

### To build your own motor, choose the:

**1 - Frame Size**  
( Imperial )

**2 - Torque**  
( Stack Length )

**3 - Winding**

**4 - Features**  
( see page 39 )

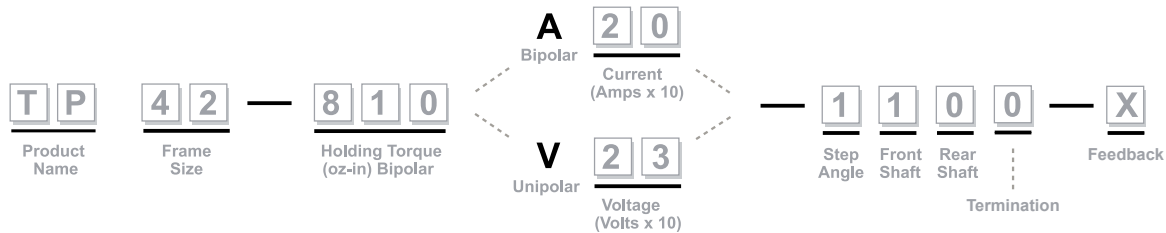

### Step 1:

### TP42 Frame Size Drawing Key

Bipolar Model	Unipolar Model	MAX Length	A	B	C	D	E	F	G	H	I	J
			Front Shaft Diameter	Front Shaft Length	Pilot Diameter	Pilot Length (Ref)	Mount Hole Callout	Mount Hole Spacing (Ref)	Flange External Dimension (Ref)	Rear Shaft Diameter	Rear Shaft Length	Encoder Length (max)
TP42-810	TP42-650	5.39 in ±0.04	0.6250 in 0.6245 in	1.38 in ±0.03	2.188 in 2.184 in	0.06 in	[4] 0.28 in ±.010 Through	3.50 in	4.19 in	0.5000 in 0.4995 in	1.25 in ±0.04	TBD
TP42-1440	TP42-1150	7.56 in ±0.04										
TP42-2100	TP42-1650	9.90 in ±0.04										

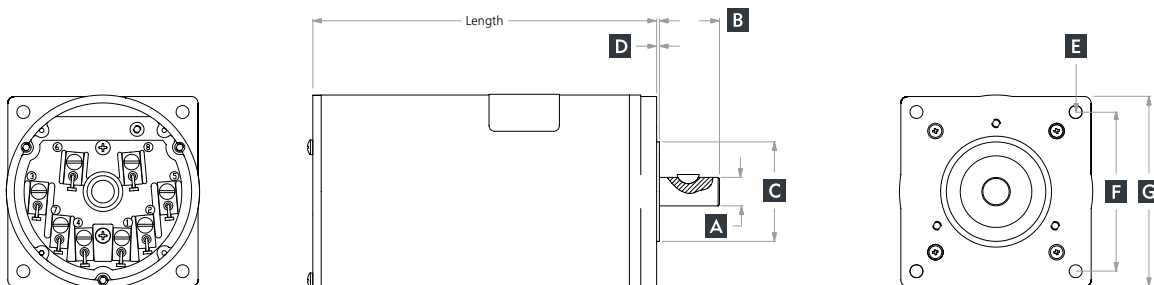

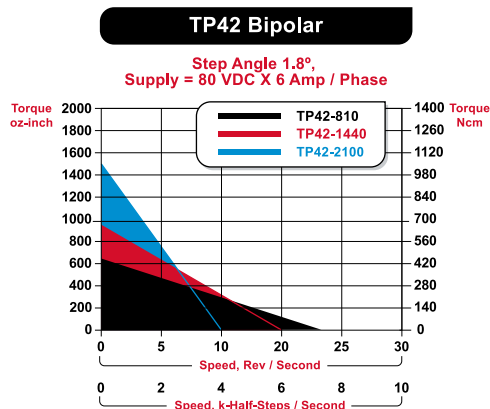
**Step 2: TP42 Torque and Mechanical Data**

Stack Size Models	Bipolar			Unipolar		
	810A	1440A	2100A	650V	1150V	1650V
Holding Torque oz-in (Ncm)	810.0 (571.94)	1440.0 (1016.78)	2100.0 (1482.81)	650.0 (458.96)	1150.0 (812.01)	1650.0 (1165.07)
Step Angle (°/step)	1.8°	1.8°	1.8°	1.8°	1.8°	1.8°
Rotor Inertia (oz-in-sec <sup>2</sup> )	0.055	0.114	0.172	0.055	0.114	0.172
Weight oz (g)	216 (6123)	320 (9072)	424 (12020)	216 (6123)	320 (9072)	424 (12020)

**Step 3: Available Windings**

Bipolar												
Imperial	810A20	810A30	810A50	1440A20	1440A30	1440A50	2100A20	2100A30	2100A50			
Current Bipolar (A/Phase)	2.0	3.0	5.0	2.0	3.0	5.0	2.0	3.0	5.0			
Phase Resistance (ohm)	3.5	1.6	0.6	5.5	2.4	0.9	6.25	3.04	1.0			
Phase Inductance (mH)	63.8	28.3	10.2	186	82.8	29.8	140	64	22.2			
Unipolar												
Imperial	650V23	650V41	650V79	650V98	1150V37	1150V46	1150V58	1150V74	1650V24	1650V32	1650V39	1650V45
Unipolar (V/Phase)	2.3	4.1	7.9	9.8	3.7	4.6	5.8	7.4	2.4	3.2	3.9	4.5
Unipolar (A/Phase)	6.1	3.5	1.8	1.4	6.1	4.7	3.8	3.1	10.4	8.4	6.8	5.2
Phase Resistance (ohm)	0.37	1.17	4.47	7	0.6	0.97	1.53	2.4	0.23	0.38	0.57	0.86
Phase Inductance (mH)	3.5	10.5	40.1	63.8	7	11.3	17.4	26.9	2.6	4	6.9	10.6
Bipolar (A/Phase)*	4.3	2.5	1.3	1.0	4.3	3.4	2.7	2.2	7.3	6.0	4.8	3.7

## TPP11M : ElectroCraft TorquePower™ Plus | Stepper Motor

Size	Holding Torque oz-in (Ncm)	Speeds up to RPS
Nema 11, 1.8°	18 (13)	140



### Quiet. Durable.

This extremely quiet hybrid stepping motor is made with ball bearings. Only available in metric configuration, sizes in metric units and has a holding torque up to 18 oz-in with a step angle accuracy of ±5%.

### To build your own motor, choose the:

**1 - Frame Size**  
( Metric )

**2 - Torque**  
( Stack Length )

**3 - Winding**

**4 - Features**  
( see page 39 )

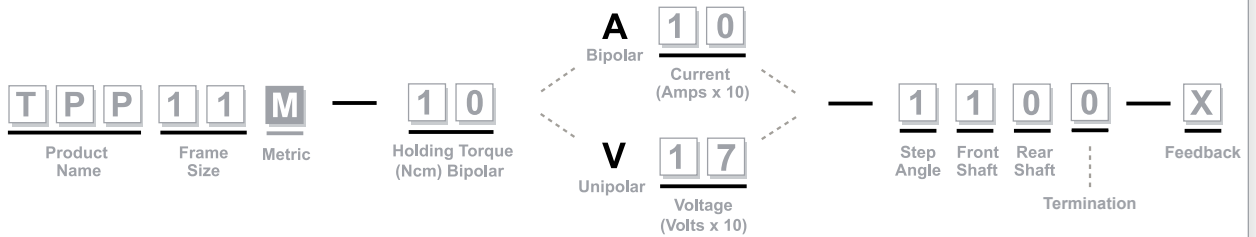

### Step 1:

### TPP11M Frame Size Drawing Key

Bipolar Model	Unipolar Model	MAX Length	A	B	C	D	E	F	G	H	I	J
			Front Shaft Diameter	Front Shaft Length	Pilot Diameter	Pilot Length (Ref)	Mount Hole Callout (Ref)	Mount Hole Spacing (Ref)	Flange External Dimension (Ref)	Rear Shaft Diameter	Rear Shaft Length	Encoder Length (max)
TPP11M-7	TPP11M-5	31.5 mm ±.08	4.999 mm	20 mm ±0.08	22.00 mm	2.0 mm	(4) M3 x 0.5-6H 3.5 mm Deep min	23.0 mm	28.0 mm	4.999 mm	9.9 mm ±0.08	16.26 mm
TPP11M-10	TPP11M-6	39.6 mm ±.08	4.986 mm		21.97 mm					4.986 mm		
TPP11M-13	TPP11M-9	50.6 mm ±.08										

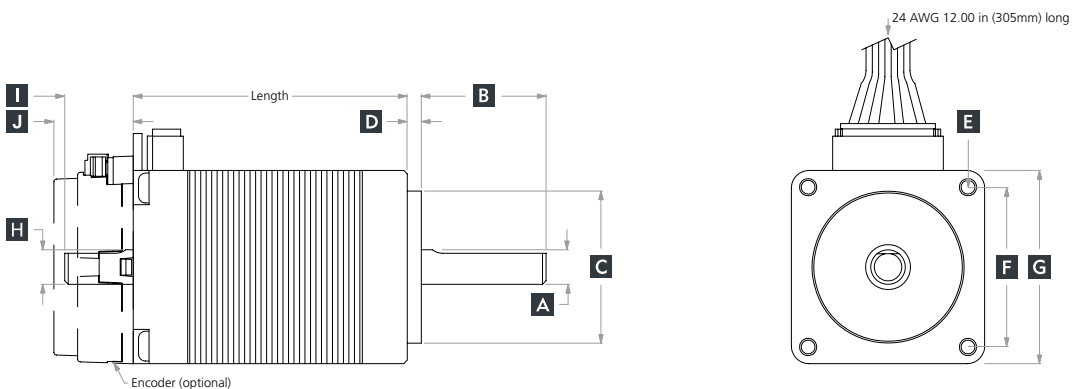

**Step 2: TP11M Torque and Mechanical Data**

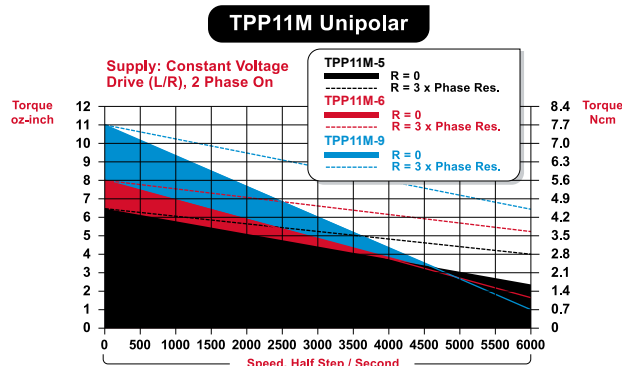
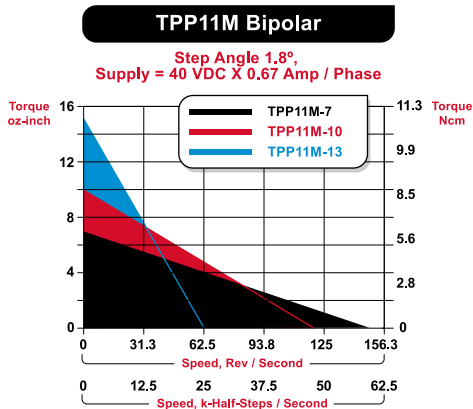

Stack Size Models	Bipolar			Unipolar		
	TPP11M - 7A	TPP11M - 10A	TPP11M - 13A	TPP11M - 5V	TPP11M - 6V	TPP11M - 9V
Holding Torque oz-in (Ncm)	9.5 (6.71)	13.7 (9.67)	18 (12.71)	6.6 (4.7)	9.6 (6.8)	13.0 (9.2)
Step Angle (°/step)	1.8°	1.8°	1.8°	1.8°	1.8°	1.8°
Rotor Inertia (oz-in-sec <sup>2</sup> )	0.000155	0.000208	0.000268	0.000155	0.000208	0.000268
Weight oz (g)	4.0 (113)	5.1 (145)	7.0 (198)	4.0 (113)	5.1 (145)	7.0 (198)

**Step 3: Available Windings**

Bipolar									
Metric	7A05	7A10	7A15	10A05	10A10	10A15	13A05	13A10	13A15
Current Bipolar (A/Phase)	0.5	1.0	1.5	0.5	1.0	1.5	0.5	1.0	1.5
Phase Resistance (ohm)	10	2.5	1.1	12.4	3.1	1.4	16.4	4.1	1.8
Phase Inductance (mH)	6.8	1.5	0.7	9.1	2.6	1	9.8	2.6	1.2
Unipolar									
Metric	5V14	5V27	6V17	6V33	9V22	9V44			
Unipolar (V/Phase)	1.4	2.7	1.7	3.3	2.2	4.4			
Unipolar (A/Phase)	1.8	0.9	1.8	0.9	1.8	0.9			
Phase Resistance (ohm)	0.7	2.8	0.9	3.4	1.2	4.6			
Phase Inductance (mH)	0.23	1	0.36	1.5	0.42	1.7			
Bipolar (A/Phase)*	1.3	0.7	1.3	0.7	1.3	0.7			

TPP

## TPP17 & TPP17M : ElectroCraft TorquePower™ Plus | Stepper Motor

Size	Holding Torque oz-in (Ncm)	Speeds up to RPS
Nema 17, 1.8°	58 (41)	80



### Precise. Compact.

This 1.8° size 17 hybrid DC stepping motor has permanently lubricated ball bearings. The bi-directional size 17 has holding torque up to 58 oz-in with a step angle accuracy of ±5%

### To build your own motor, choose the:

**1 - Frame Size**  
( Metric or Imperial )

**2 - Torque**  
( Stack Length )

**3 - Winding**

**4 - Features**  
( see page 39 )

a. **TPP17** — **29** — **A 10**  
Product Name Frame Size Holding Torque (oz-in) Bipolar Current (Amps x 10)

b. **TPP17M** — **21** — **V 40**  
Product Name Frame Size Optional Metric Holding Torque (Ncm) Bipolar Unipolar Voltage (Volts x 10)

— **1100** — **X**  
Step Angle Front Shaft Rear Shaft Termination Feedback

### Step 1:

### TPP17 & TPP17M Frame Size Drawing Key

Bipolar Model	Unipolar Model	MAX Length	A	B	C	D	E	F	G	H	I	J
			Front Shaft Diameter	Front Shaft Length	Pilot Diameter	Pilot Length (Ref)	Mount Hole Callout (Ref)	Mount Hole Spacing (Ref)	Flange External Dimension (Ref)	Rear Shaft Diameter	Rear Shaft Length	Encoder Length (max)
TPP17-29	TPP17-22	1.28 in ±0.03	0.1968 in 0.1963 in	0.79 in ±0.03	0.8660 in 0.8648 in	0.08 in	[4] 4-40 UNC-2B 0.17 in Deep Min	1.22 in	1.65 in	0.1968 in 0.1963 in	0.53 in ±0.04	0.70 in
TPP17-47	TPP17-36	1.52 in ±0.03										
TPP17-58	TPP17-44	1.85 in ±0.03										
TPP17M-21	TPP17M-16	32.5 mm ±0.8	4.999 mm 4.986 mm	20 mm ±0.8	22.00 mm 21.97 mm	2.0 mm	(4) M3 x 0.5-6H 4.31 mm Deep min	30.9 mm	41.9 mm	4.999 mm 4.986 mm	13.5 mm ±1.02	17.8 mm
TPP17M-33	TPP17M-25	38.6 mm ±0.8										
TPP17M-41	TPP17M-31	47.0 mm ±0.8										

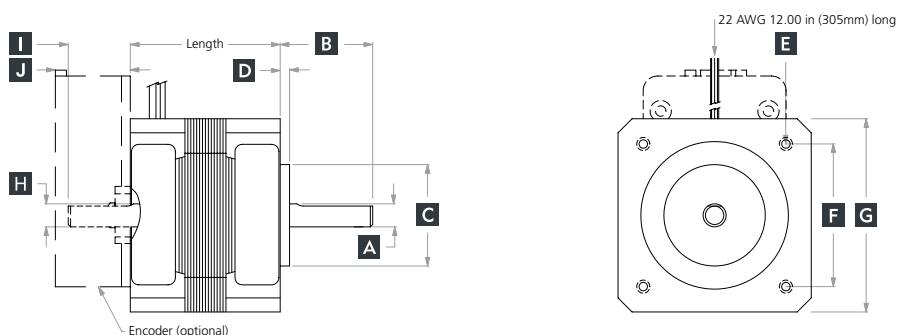



**Step 2: TPP17 & TPP17M Torque and Mechanical Data**

**TPP17 & TPP17M Bipolar**

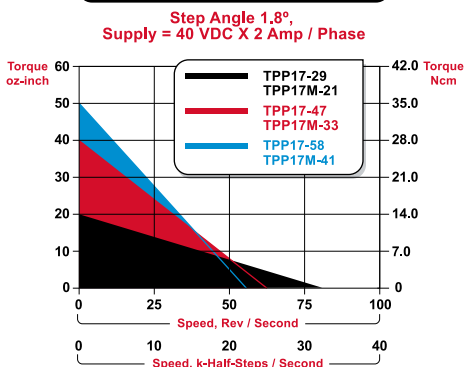

**TPP17 & TPP17M Unipolar**

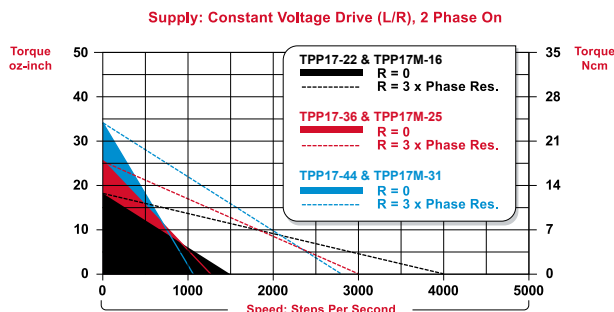

Stack Size Models	Bipolar			Unipolar		
Imperial	29A	47A	58A	22V	36V	44V
Metric	21A	33A	41A	16V	25V	31V
Holding Torque oz-in (Ncm)	29.0 (20.5)	47.0 (33.2)	58.0 (41.0)	22.2 (15.7)	36.1 (25.5)	44.4 (31.4)
Step Angle (°/Step)	1.8°	1.8°	1.8°	1.8°	1.8°	1.8°
Rotor Inertia (oz-in-sec <sup>2</sup> )	0.00053	0.00081	0.00106	0.00053	0.00081	0.00106
Weight oz (g)	7.0 (198)	9 (255)	11.8 (335)	7.0 (198)	9 (255)	11.8 (335)

**Step 3: Available Windings**

**Bipolar**

	29A10	29A15	29A20	47A10	47A15	47A20	58A10	58A15	58A20
Imperial									
Metric									
Current Bipolar (A/Phase)	1.0	1.5	2.0	1.0	1.5	2.0	1.0	1.5	2.0
Phase Resistance (ohm)	3.8	1.9	0.95	4.7	2.4	1.2	5.2	2.5	1.2
Phase Inductance (mH)	4.8	2.3	1.2	9.1	4.7	2.3	8.4	4.3	2.2

**Unipolar**

	22V40	22V60	22V96	22V120	36V40	36V60	36V120	36V240	44V40	44V60	44V120	44V240
Imperial												
Metric												
Unipolar (V/Phase)	4.0	6.0	9.6	12.0	4.0	6.0	12.0	24.0	4.0	6.0	12.0	24.0
Unipolar (A/Phase)	1.0	0.6	0.4	0.3	1.2	0.8	0.4	0.2	1.2	0.8	0.4	0.2
Phase Resistance (ohm)	4.2	9.6	24	38.5	3.3	7.5	30	120	3.3	7.5	30	120
Phase Inductance (mH)	2.5	5.8	15	23	3.2	7	28	112	2.8	7	28	112
Bipolar (A/Phase)*	0.7	0.4	0.3	0.2	0.9	0.6	0.3	0.1	0.9	0.6	0.3	0.1

## TPP23 & TPP23M : ElectroCraft TorquePower™ Plus | Stepper Motor

Size	Holding Torque oz-in (Ncm)	Speeds up to RPS
Nema 23, 0.9° or 1.8°	240 (169)	90



### Powerful. Precise.

This 1.8° degree size 23 hybrid DC stepping motor has permanently lubricated ball bearings. The bi-directional size 23 has holding torque up to 240 oz-in with a step angle accuracy of ±3%.

### To build your own motor, choose the:

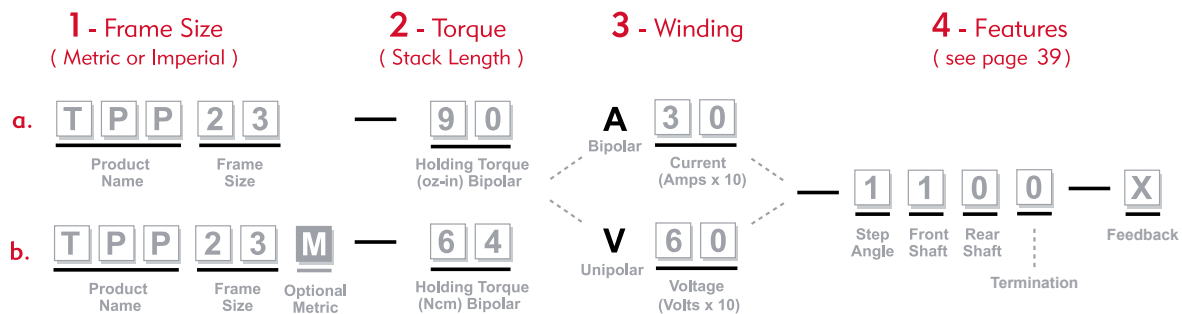

### Step 1:

### TPP23 & TPP23M Frame Size Drawing Key

Bipolar Model	Unipolar Model	MAX Length	A	B	C	D	E	F	G	H	I	J
			Front Shaft Diameter	Front Shaft Length	Pilot Diameter	Pilot Length (Ref)	Mount Hole Callout (Ref)	Mount Hole Spacing (Ref)	Flange External Dimension (Ref)	Rear Shaft Diameter	Rear Shaft Length	Encoder Length (max)
TPP23-90	TPP23-72	1.75 in ±0.03										
TPP23-150	TPP23-120	2.21 in ±0.03	0.2500 in 0.2495 in	0.81 in ±0.03	1.502 in 1.498 in	0.06 in	[4] 0.205 in ±0.01 Through	1.86 in	2.22 in	0.2500 in 0.2495 in	0.53 in ±0.04	0.70 in
TPP23-240	TPP23-190	3.09 in ±0.03										
TPP23M-64	TPP23M-50	44.5 mm ±0.8										
TPP23M-106	TPP23M-84	56.1 mm ±0.8	7.988 mm 7.976 mm	20.5 mm ±0.8	38.15 mm 38.05 mm	1.5 mm	(4) 5.08 mm ±0.25 Through	47.1 mm	56.4 mm	4.998 mm 4.986 mm	13.5 mm ±0.8	17.8 mm
TPP23M-170	TPP23M-134	78.5 mm ±0.8										

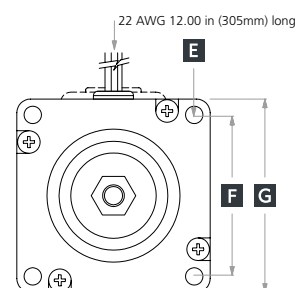
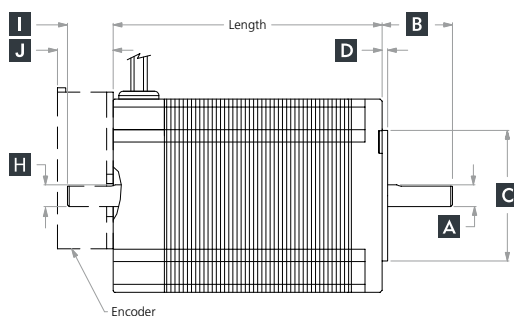

**Step 2: TPP23 & TPP23M Torque and Mechanical Data**

**TPP23 & TPP23M Bipolar**

Step Angle 1.8°, Supply = 80 VDC X 3 Amp / Phase

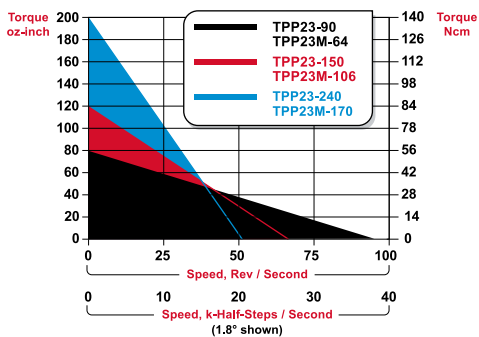

**TPP23 & TPP23M Unipolar**

Supply: Constant Voltage Drive (L/R), 2 Phase On

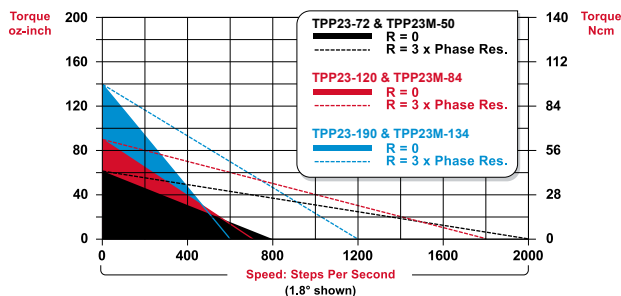

Stack Size Models	Bipolar			Unipolar		
	Imperial	Metric		Imperial	Metric	
Imperial	90A	150A	240A	72V	120V	190V
Metric	64A	106A	170A	50V	84V	134V
Holding Torque oz-in (Ncm)	90.0 (63.55)	150.0 (105.92)	240.0 (169.46)	72.0 (50.8)	120.0 (84.7)	190.0 (134.17)
Step Angle (°/Step)	0.9° or 1.8°	0.9° or 1.8°	0.9° or 1.8°	0.9° or 1.8°	0.9° or 1.8°	0.9° or 1.8°
Rotor Inertia (oz-in-sec <sup>2</sup> )	0.002	0.0035	0.0061	0.002	0.0035	0.0061
Weight oz (g)	17 (482)	24 (680)	37 (1049)	17 (482)	24 (680)	37 (1049)

**Step 3: Available Windings**

**Bipolar**

	90A10	90A20	90A30	150A10	150A20	150A30	240A10	240A20	240A30
Imperial	90A10	90A20	90A30	150A10	150A20	150A30	240A10	240A20	240A30
Metric	64A10	64A20	64A30	106A10	106A20	106A30	170A10	170A20	170A30
Current Bipolar (A/Phase)	1.0	2.0	3.0	1.0	2.0	3.0	1.0	2.0	3.0
Phase Resistance (ohm)	5.78	1.5	0.6	7.92	1.9	0.8	9.13	2.33	1
Phase Inductance (mH)	20.3	5.2	2	35	8.6	3.5	45.4	11.5	4.8

**Unipolar**

	72V18	72V30	72V60	72V120	120V23	120V38	120V60	120V76	120V154	190V28	190V45	190V60	190V92	190V179
Imperial	72V18	72V30	72V60	72V120	120V23	120V38	120V60	120V76	120V154	190V28	190V45	190V60	190V92	190V179
Metric	50V18	50V30	50V60	50V120	84V23	84V38	84V60	84V76	84V154	134V28	134V45	134V60	134V92	134V179
Unipolar (V/Phase)	1.8	3.0	6.0	11.9	2.3	3.8	6.0	7.6	15.4	2.8	4.5	6.0	9.2	17.9
Unipolar (A/Phase)	3.0	2.0	1.0	0.5	3.0	2.0	1.3	1.0	0.5	3.0	2.0	1.5	1.0	0.5
Phase Resistance (ohm)	0.61	1.57	6	23.5	0.76	1.91	4.73	7.59	30.9	0.92	2.24	4	9.23	35.7
Phase Inductance (mH)	1	2.6	10.8	41.4	1.6	4.2	11	17.7	67.3	2.1	5.2	9.25	22.5	93.8
Bipolar (A/Phase)*	2.1	1.4	0.7	0.4	2.1	1.4	0.9	0.7	0.4	2.1	1.4	1.1	0.7	0.4

## TPP34 & TPP34M : ElectroCraft TorquePower™ Plus | Stepper Motor

Size	Holding Torque oz-in (Ncm)	Speeds up to RPS
Nema 34, 1.8°	1190 (840)	35



### Compact. Force.

This bi-directional, 1.8° size 34 hybrid DC stepping motor provides a lot of torque in a relatively small size. The TPP34 has holding torque up to 1190 oz-in with a step angle accuracy of ±3%.

### To build your own motor, choose the:

**1 - Frame Size**  
( Metric or Imperial )

**2 - Torque**  
( Stack Length )

**3 - Winding**

**4 - Features**  
( see page 39 )

**a.** **TPP** **34** — **396** **A** **30**  
Product Name Frame Size Holding Torque (oz-in) Bipolar Current (Amps x 10)

**b.** **TPP** **34** **M** — **280** **V** **30**  
Product Name Frame Size Optional Metric Holding Torque (Ncm) Bipolar Voltage (Volts x 10)

**1** **1** **0** **0** — **X**  
Step Angle Front Shaft Rear Shaft Termination Feedback

### Step 1:

### TPP34 & TPP34M Frame Size Drawing Key

Bipolar Model	Unipolar Model	MAX Length	A	B	C	D	E	F	G	H	I	J
			Front Shaft Diameter	Front Shaft Length	Pilot Diameter	Pilot Length (Ref)	Mount Hole Callout (Ref)	Mount Hole Spacing (Ref)	Flange External Dimension (Ref)	Rear Shaft Diameter	Rear Shaft Length	Encoder Length (max)
TPP34-396	TPP34-305	2.60 in ±0.04										
TPP34-793	TPP34-610	3.78 in ±0.04	0.5000 in 0.4995 in	1.46 in ±0.04	2.876 in 2.874 in	0.08 in	[4] 0.260 in ±0.01 Through	2.74 in	3.38 in	0.5000 in 0.4995 in	1.34 in ±0.04	0.70 in
TPP34-1190	TPP34-916	4.96 in ±0.04										
TPP34M-280	TPP34M-215	66.0 mm ±1.0										
TPP34M-560	TPP34M-430	96.0 mm ±1.0	14.000 mm 13.988 mm	37 mm ±1.0	73.05 mm 73.00 mm	2.0 mm	(4) 6.60 mm ±0.25 Through	69.6 mm	85.8 mm	14.000 mm 13.988 mm	34.0 mm ±1.0	17.8 mm
TPP34M-840	TPP34M-646	126.0 mm ±1.0										

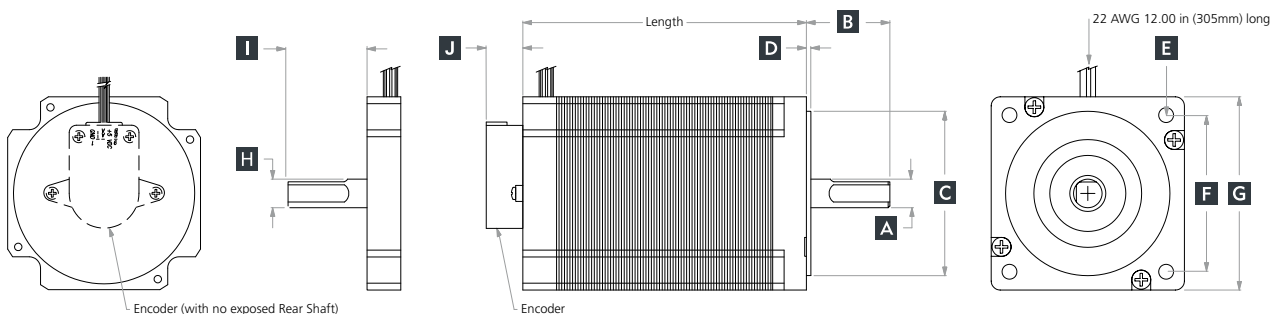

**Step 2: TPP34 & TPP34M Torque and Mechanical Data**

**TPP34 & TPP34M Bipolar**

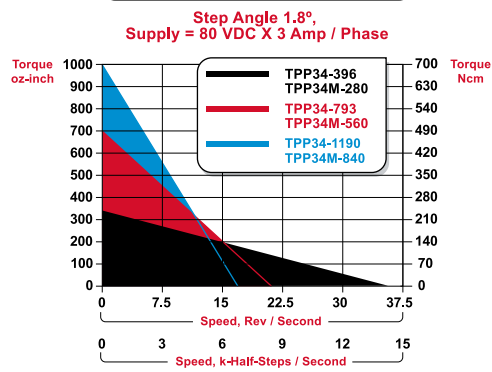

**TPP34 & TPP34M Unipolar**

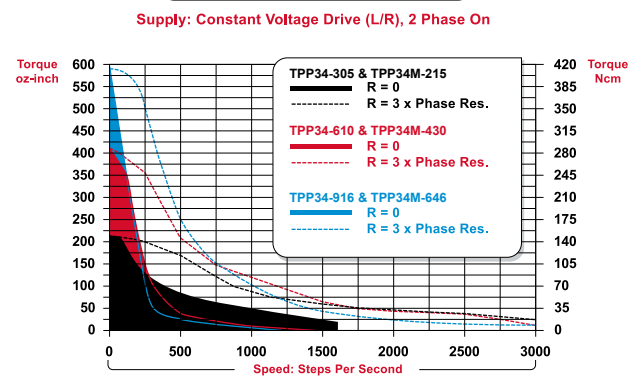

Stack Size Models	Bipolar			Unipolar		
	Imperial	Metric		Imperial	Metric	
Imperial	396A	280A	793A, 1190A	305V	215V	610V, 916V
Metric	396A	280A	560A, 840A	305V	215V	610V, 916V
Holding Torque (oz-in (Ncm))	396.0 (279.62)	280.0 (196.13)	793.0 (559.94), 1190.0 (840.26)	305.0 (215)	215.0 (152.14)	610 (430), 916.0 (650)
Step Angle (°/Step)	1.8°	1.8°	1.8°	1.8°	1.8°	1.8°
Rotor Inertia (oz-in-sec <sup>2</sup> )	0.0198	0.0198	0.0382, 0.0566	0.0198	0.0198	0.0382, 0.0566
Weight (oz (g))	62 (1758)	62 (1758)	99 (2807), 141 (3997)	62 (1758)	62 (1758)	99 (2807), 141 (3997)

**Step 3: Available Windings**

	Bipolar								
	Imperial	Metric	Imperial	Metric	Imperial	Metric	Imperial	Metric	Imperial
Imperial	396A20	280A20	396A30	280A30	396A50	280A50	793A20	560A20	1190A20
Metric	396A20	280A20	396A30	280A30	396A50	280A50	793A20	560A20	1190A20
Current Bipolar (A/Phase)	2.0	2.0	3.0	3.0	5.0	5.0	2.0	2.0	5.0
Phase Resistance (ohm)	2.52	2.52	1	1	0.4	0.4	3.93	3.93	0.68
Phase Inductance (mH)	21.9	21.9	8.67	8.67	3.44	3.44	34.3	34.3	6.98
	Unipolar								
	Imperial	Metric	Imperial	Metric	Imperial	Metric	Imperial	Metric	Imperial
Imperial	305V23	215V23	305V30	215V30	305V50	215V50	610V35	430V35	916V39
Metric	305V23	215V23	305V30	215V30	305V50	215V50	610V35	430V35	916V39
Unipolar (V/Phase)	2.3	2.3	3.0	3.0	5.0	5.0	3.5	3.5	8.7
Unipolar (A/Phase)	4.5	4.5	3.0	3.0	2.0	2.0	4.5	4.5	2.0
Phase Resistance (ohm)	0.5	0.5	1	1	2.52	2.52	0.78	0.78	4.33
Phase Inductance (mH)	2.17	2.17	4.34	4.34	10.9	10.9	3.4	3.4	22.2
Bipolar (A/Phase)*	3.2	3.2	2.1	2.1	1.4	1.4	3.2	3.2	1.4

TPP

## TPE17 & TPE17M : ElectroCraft TorquePower™ Enhanced | Stepper Motor

Size	Holding Torque oz-in (Ncm)	Speeds up to RPS
Nema 17	78(55)	80



### Compact. Powerful.

The ElectroCraft Torque Power™ Enhanced Nema 17 is a high performance stepper motor incorporating creative design and manufacturing techniques to offer improved holding torque. Motors are available in both bipolar and unipolar windings with a variety of shaft configurations and encoder options to meet the needs of any application.

### To build your own motor, choose the:

**1 - Frame Size**  
( Metric or Imperial )

a. **TPE17**  
Product Name      Frame Size

b. **TPE17M**  
Product Name      Frame Size      Optional Metric

**2 - Torque**  
( Stack Length )

— **45**  
Holding Torque (oz-in) Bipolar

— **32**  
Holding Torque (Ncm) Bipolar

**3 - Winding**

**A** **10**  
Bipolar      Current (Amps x 10)

**V** **10**  
Unipolar      Voltage (Volts x 10)

**4 - Features**  
( see page 39 )

— **1111** — **X**  
Step Angle    Front Shaft    Rear Shaft    Termination    Encoder

### Step 1:

### TPE17 & TPE17M Frame Size Drawing Key

Bipolar Model	Unipolar Model	MAX Length	A	B	C	D	E	F	G	H	I	J
			Front Shaft Diameter	Front Shaft Length	Pilot Diameter	Pilot Length (Ref)	Mount Hole Callout (Ref)	Mount Hole Spacing (Ref)	Flange External Dimension (Ref)	Rear Shaft Diameter	Rear Shaft Length	Encoder Length (max)
TPE17-45	TPE17-35	1.42 in ±0.03	0.1968 in 0.1963 in	0.79 in ±0.03	0.8660 in 0.8648 in	0.08 in	[4] 4-40 UNC-2B 0.17 in Deep Min	1.22 in ±0.07	1.65 in square	0.1968 in 0.1963 in	0.53 in ±0.04	0.70 in
TPE17-63	TPE17-48	1.62 in ±0.03										
TPE17-78	TPE17-60	1.93 in ±0.03										
TPE17M-32	TPE17M-25	36.1 mm ±0.8	4.999 mm 4.986 mm	20 mm ±0.8	22.00 mm 21.97 mm	2.0 mm	(4) M3 x 0.5-6H 4.31 mm Deep min	31.0 mm ±0.15	42 mm square	4.999 mm 4.986 mm	13.5 mm ±1.0	17.8 mm
TPE17M-44	TPE17M-34	41.1 mm ±0.8										
TPE17M-55	TPE17M-42	49.1 mm ±0.8										

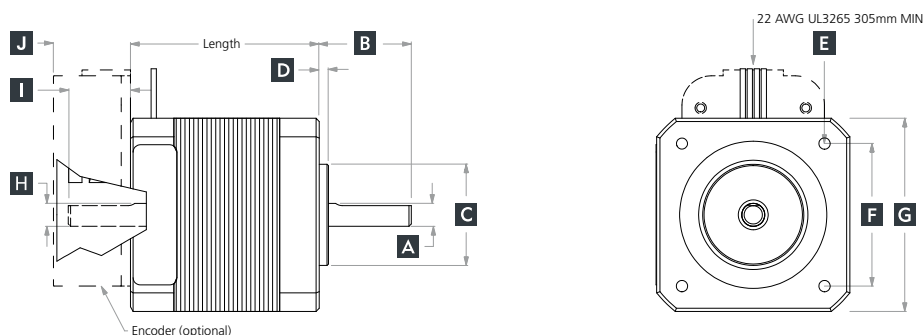



Step 2: TPE17 & TPE17M Torque and Mechanical Data						
Stack Size Models	Bipolar			Unipolar		
Imperial	45A	63A	78A	35V	48V	60V
Metric	32A	44A	55A	25V	34V	42V
Holding Torque oz-in (Ncm)	45 (32)	63 (44)	78 (55)	35 (25)	48 (34)	60 (42)
Step Angle °/step	1.8°	1.8°	1.8°	1.8°	1.8°	1.8°
Rotor Inertia oz-in-sec <sup>2</sup> (kg-cm <sup>2</sup> )	0.00058 (0.0407)	0.00086 (0.0606)	0.00117 (0.0827)	0.00058 (0.0407)	0.00086 (0.0606)	0.00117 (0.0827)
Weight oz (g)	9 (250)	11 (300)	13 (370)	9 (250)	11 (300)	13 (370)

Step 3: Available Windings									
Bipolar									
Imperial	45A10	45A15	45A20	63A10	63A15	63A20	78A10	78A15	78A20
Metric	32A10	32A15	32A20	44A10	44A15	44A20	55A10	55A15	55A20
Current Bipolar (A/Phase)	1.00	1.50	2.00	1.00	1.50	2.00	1.00	1.50	2.00
Phase Resistance (ohm)	4.28	1.90	1.07	4.99	2.22	1.25	6.12	2.72	1.58
Phase Inductance (mH)	7.55	3.36	1.89	9.30	4.14	2.32	14.42	6.42	3.40
Unipolar									
Imperial	35V40	35V60	35V120	48V40	48V60	48V120	60V40	60V60	60V120
Metric	25V40	25V60	25V120	34V40	34V60	34V120	42V40	42V60	42V120
Unipolar (V/Phase)	4.0	6.0	12.0	4.0	6.0	12.0	4.0	6.0	12.0
Unipolar (A/Phase)	1.05	0.70	0.35	1.27	0.85	0.45	1.47	0.98	0.49
Phase Resistance (ohm)	3.81	8.56	34.24	3.15	7.06	26.68	2.72	6.12	24.49
Phase Inductance (mH)	3.37	7.56	30.24	2.93	6.58	26.33	3.21	7.21	28.86
Bipolar (A/Phase)*	0.74	0.50	0.25	0.90	0.60	0.32	1.04	0.69	0.35

**TPE17 & TPE17M Speed - Torque Curves**

**Bipolar**

**TPE17-45A10**  
**TPE17M-32A10**  
1 Amp/phase (RMS)

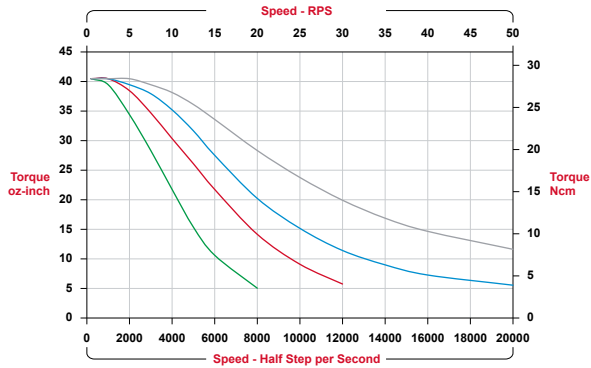
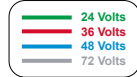

**TPE17-63A10**  
**TPE17M-44A10**  
1 Amp/phase (RMS)

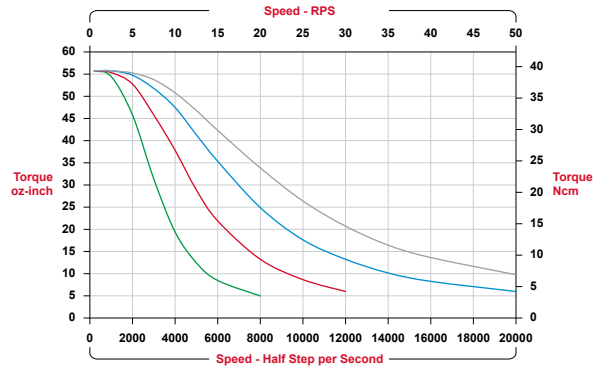
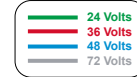

**TPE17-45A15**  
**TPE17M-32A15**  
1.5 Amp/phase (RMS)

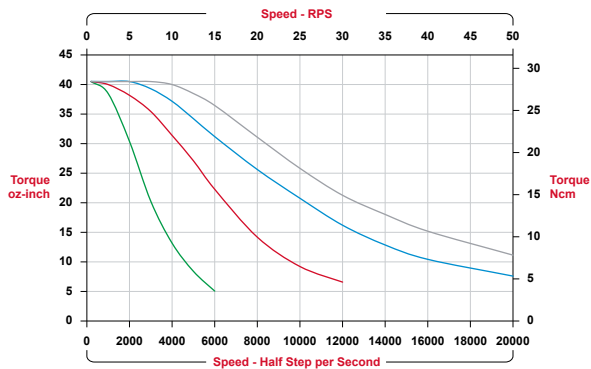

**TPE17-63A15**  
**TPE17M-44A15**  
1.5 Amp/phase (RMS)

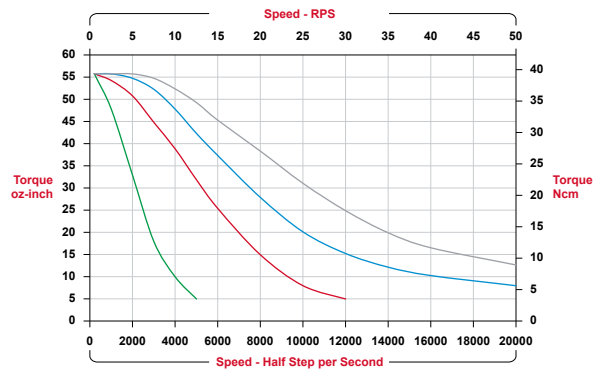
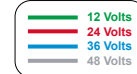

**TPE17-45A20**  
**TPE17M-32A20**  
2 Amp/phase (RMS)

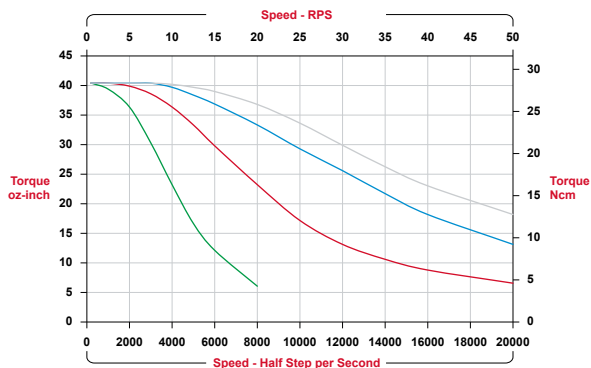
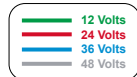

**TPE17-63A20**  
**TPE17M-44A20**  
2 Amp/phase (RMS)

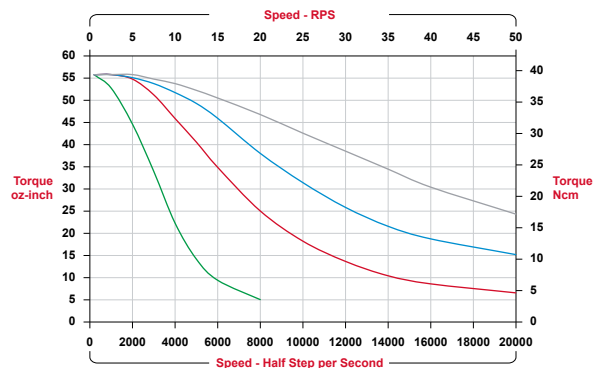
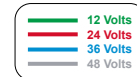



TPE17 & TPE17M Speed - Torque Curves

Bipolar

Unipolar

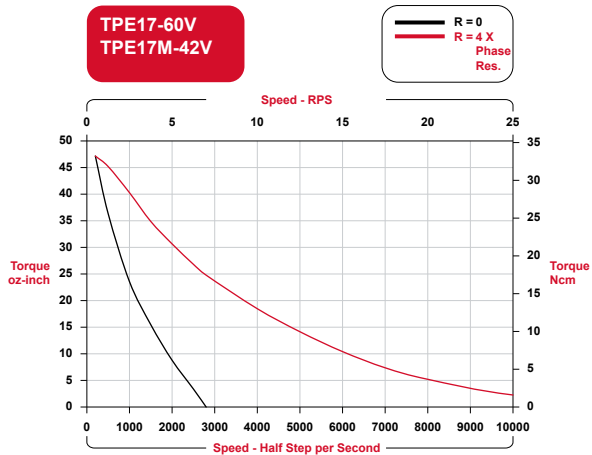
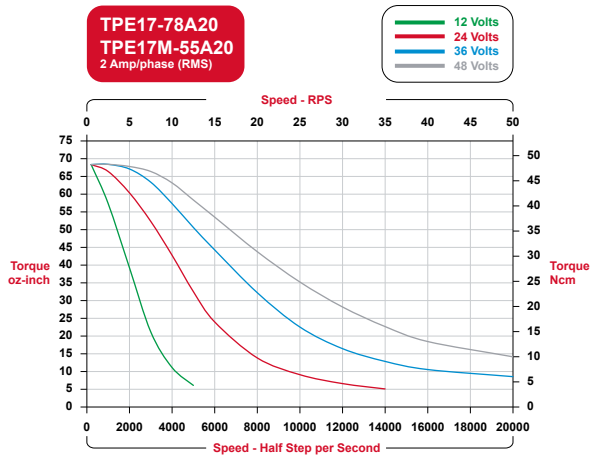
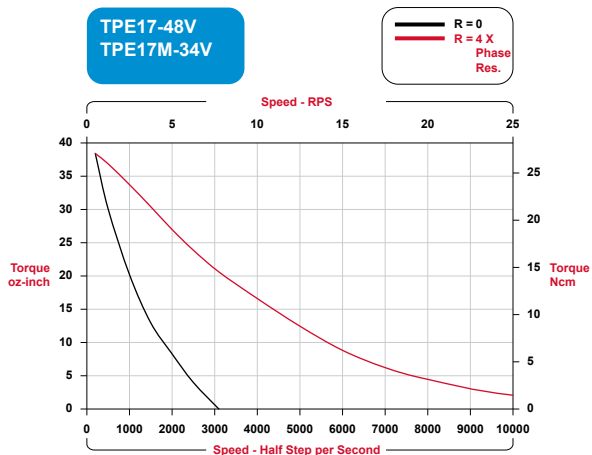
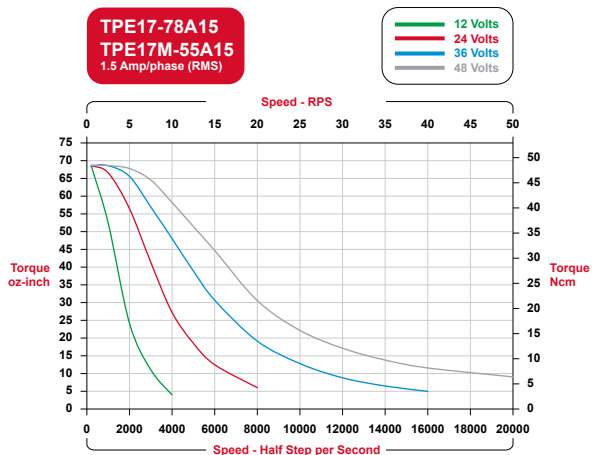
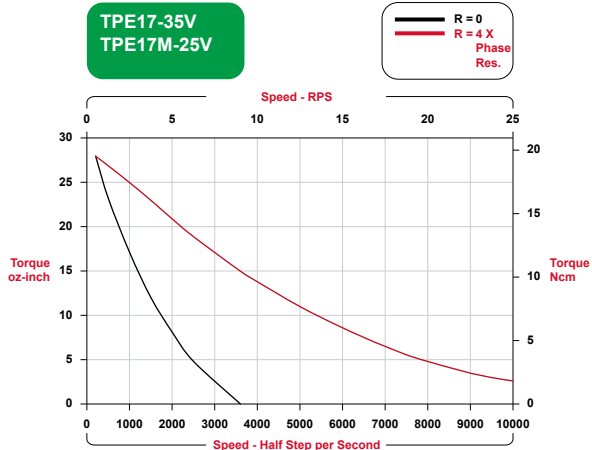
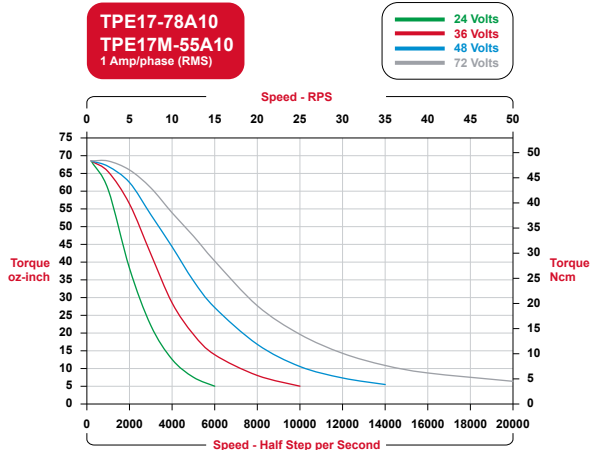

TPE

## SA45 : Electrocraft CompletePower™ | Motion Control

Power Supply Voltage	Nominal Current	Phases	Operation Mode		Special Functions		
			Fullstep	Micro stepping	Integrated Oscillator	Current Fallback	Anti-Resonance Anti-Noise
11 - 48	5 / 10	2	●	●	●	●	●



### For Stepper Motors. Up to 480W.

This bipolar stepper drive provides microstepping to 1/16 built into a fully enclosed rugged aluminum case. It can be DIN-rail mounted or panel mounted for fast integration. The mode of operation is set by simple DIP switches. Features include an internal oscillator that allows operation of the drive at a internal speed set point or with an external analog speed reference that can scale this set point. Both the 5 A and 10 A versions of this drive can be powered by the same range of voltage supplies. This drive is protected against over-current and overtemperature and incorporates the state of the art dual full bridge MOSFET driver for maximum efficiency. Connectivity is tool-free with RJ45-CAT5 plugs for the control inputs and push-type terminals for power.

### Drive Model Example

<b>S</b>	<b>A</b>	<b>4</b>	<b>5</b>	<b>10</b>
Drive Technology	Revision	# Quadrants	Voltage 10x VDC	Nominal Amps

### SA45 Outline Drawing



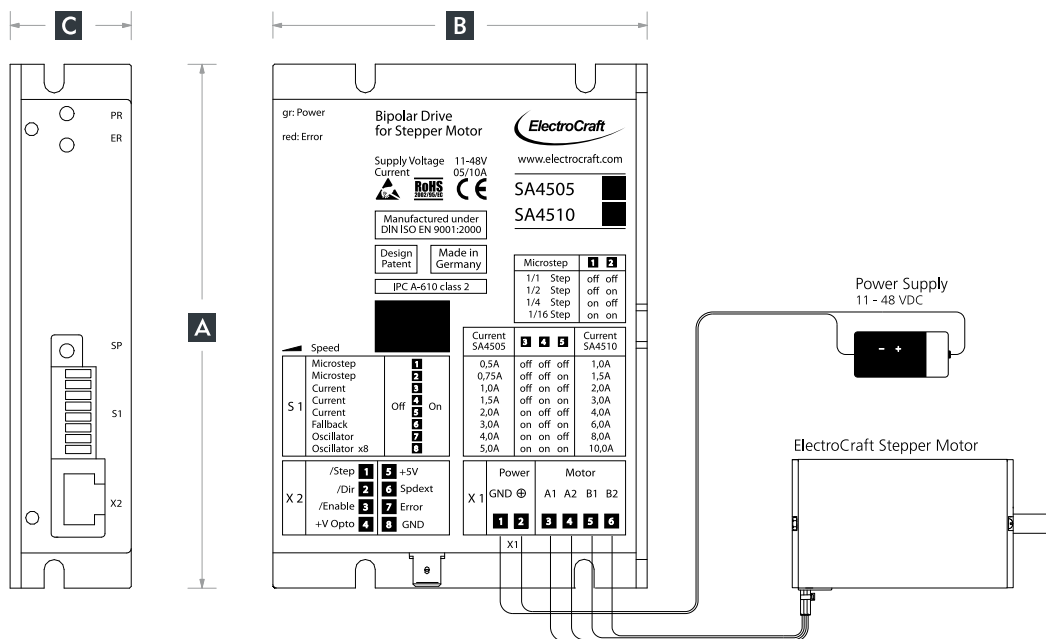



Model	A	B	C	Weight oz (g)
	Length in (mm)	Width in (mm)	Height in (mm)	
SA4505	4.69 (119.0)	3.35 (85.0)	1.08 (28)	7.05 (200)
SA4510				7.76 (220)



### SA45 Specifications

Model Number	Power Supply Voltage (VDC)	Nominal Current (Amps)	Max. Power with Heatsink (Watts)	Frequency of power output stage (kHz)	Efficiency (%)
SA4505	11 - 48	5	240	50	95
SA4510	11 - 48	10	480	50	95
Control Inputs					
Enable			Optical, Ri = 1 kOhm; max. 20 mA		
Direction			Optical, Ri = 1 kOhm; max. 20 mA		
Step			Optical, Ri = 1 kOhm; max. 20 mA; 250 kHz		
Speed ext.			+1 to +5 VDC; Ri = 100 kOhm		
Switches					
Microstep			1/1; 1/2; 1/4; 1/16		
Current			0,5 A to 5 A / 1 A to 10 A		
Fallback			on / off		
Oscillator			on / off		
Oscillator x8			on / off		
Outputs					
Auxiliary voltage source +5V			+5 VDC / 50 mA		
Fault			Optical, max. 20 mA		
Display					
LEDs			green= Power / red = Error		
Function of Potentiometers					
Speed			Range: 4 Hz - 500kHz / 40 Hz - 4800 Hz		
Ambient conditions					
Operation temperature (°C)			-10 to +45		
Storage temperature (°C)			-40 to +85		
Humidity Range Not Condensing (%rel)			20 to 80 % rel.		
Mode of Operation					
Fullstep; Microstep: 1/2, 1/4, 1/16					

### Available Accessories for SA45 (details see page 40)

IA210x	CAxxx	HA3008	HA3018	HA3028	MA0025	WA2509
						

ELECTRO-CRAFT  
**PRO** SERIES



*Precision positioning allows microscopic inspection and analysis*



## Programmable Servo Drive

Compact drive solution for rotary or linear brushless, stepper or PMDC brush motors.

The ElectroCraft PRO Series Programmable Servo Drives are based on a new design concept offering a cost effective, compact and modular solution for the control of rotary or linear brushless, stepper or PMDC brush motors of powers up to 385W, with 48V nominal voltage.

Designed to support both low and high-volume applications, the ElectroCraft PRO Series drive integrates advanced motor control and motion control functionality in a single plug-in module or stand-alone drive. The PRO Series Drives offer a flexible and modular solution in two form factors: PCB Mount (PE models) or built into a stand-alone package with pluggable connectors (SA models). With the comprehensive and flexible motion instruction set, the PRO Series Drives are intelligent drives that are programmable for many applications and levels of experience.



### The drive can operate:

- As a single-axis motion controller, autonomously running the program residing in its non-volatile memory.
- As an intelligent slave executing motion sequences triggered by input lines.
- As a part of a multi-axis, distributed motion control solution in either stand-alone or slave configurations.
- As an intelligent slave executing motion sequences triggered by commands received via RS-232 or CAN bus communication.

*Coordinated motion helps advance medical diagnostics*

## MotionPRO Suite User Interface

Easy configuration, tuning and programming

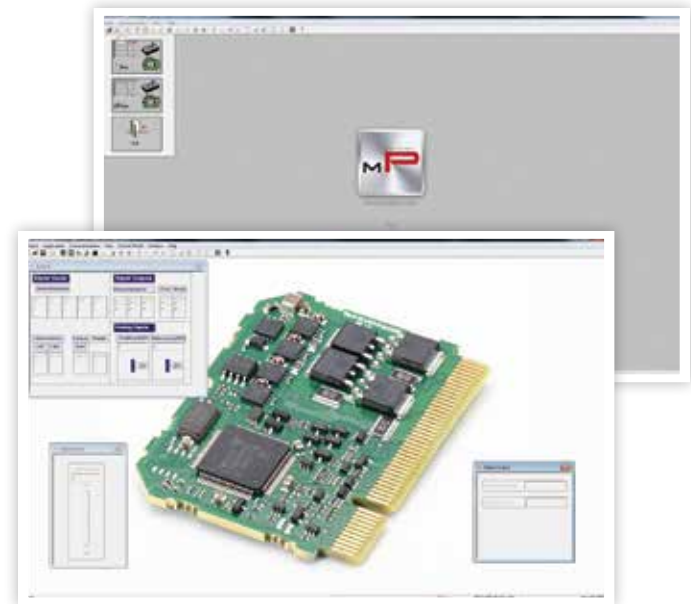

The configuration, tuning and programming of the PRO-A04V36 drive is easy with ElectroCraft's powerful MotionPRO Suite user interface.

### Flexibility – Control schemes supported by the PRO-A04V36x Drive

Motor Types (rotary or linear)	Torque Control	Speed Control	Position Control
Brushless	✓	✓	✓
Stepper	✓	✓	✓
PMDC Brush	✓	✓	✓

### Motor – sensor configurations

Motor Types	Brushless	Stepper (2-phase)	PMDC Brush
Incr. Encoder	✓	✓	✓
Incr. Encoder + Hall	✓		
Analog Sin/Cos encoder	✓		
Linear Halls	✓		
Tacho			✓
Open-loop (no sensor)		✓	

NOTE: SSI, EnDAT, BiSS encoders and Resolver feedback is possible with an additional feedback extension module

### Features

- Fully digital servo drive suitable for the control of rotary or linear brushless, stepper or PMDC brush motors
- Very compact design
- Standard PCIe 4x mating connectors (PE Versions)
- Sinusoidal or trapezoidal (Hall-based) control of brushless motors
- Open or closed-loop control of 2-phase stepper motors
- Various modes of operation, including: torque, speed or position control; position or speed profiles, external analogue reference or sent via communication bus
- Comprehensive motion instruction set for the definition and execution of motion sequences
- CAN-Bus 2.0B up to 1 Mbit/s (CANopen (CiA 301v4.2 and 402v3.0) protocols)
- Single power supply: 11-48V; optional logic supply: 9-36V
- Digital and analogue I/Os:
  - 8 Digital inputs: 5-36V, NPN [Enable, 2 Limit switches, plus 5 general purpose]
  - 5 Digital outputs: 5-36V, 0.5A, 5 NPN open-collector [Ready, Error, plus 3 general purpose]
  - 2 Analogue inputs: 12-bit, 0-5V [Reference, Feedback or general-purpose]
- Standalone operation with stored motion sequences
- RS-232 serial communication
- Switching Frequency up to 100kHz
- Operating ambient temperature: 0-40°C
- Feedback devices supported:
  - Incremental quad encoder (single-ended, open collector and differential)
  - Analogue sine/cosine incremental encoder (differential 1Vpp)
  - Digital and linear Hall sensors
  - Support for absolute feedback (SSI, BiSS, EnDAT and resolver via additional extension module)
- Hardware protections: short-circuit (between motor phases and from motor phases to GND), over-voltage, under-voltage and I<sup>2</sup>t

**PRO-A04V36: PRO Series** | Programmable Servo Drive



**Drive Model Example**

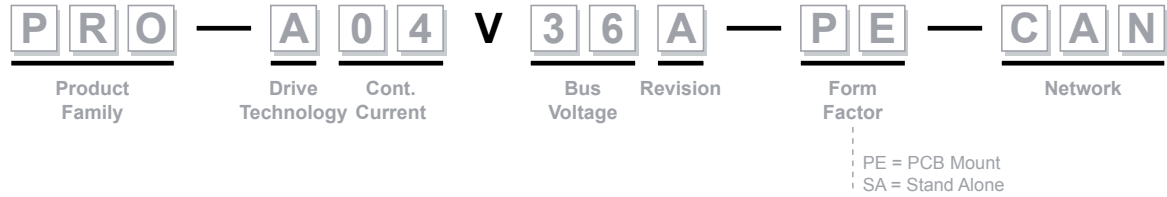

**PCB Mount PRO-A04V36x-PE-CAN Outline Drawing**

Model	A	B	C	Weight oz (g)
	Length in (mm)	Width in (mm)	Height in (mm)	
PRO-A04V36A-PE-CAN	2.2 (56)	1.1 (28.8)	0.3 (7.9)	0.35 (10)

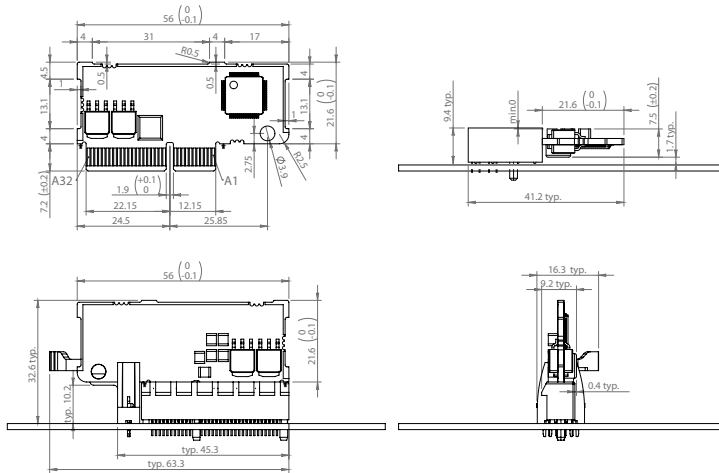

**Stand-alone PRO-A04V36x-SA-CAN Outline Drawing**

Model	A	B	C	Weight oz (g)
	Length in (mm)	Width in (mm)	Height in (mm)	
PRO-A04V36A-SA-CAN	3.15 (80)	2.17 (55)	0.64 (16.3)	2.5 (70)

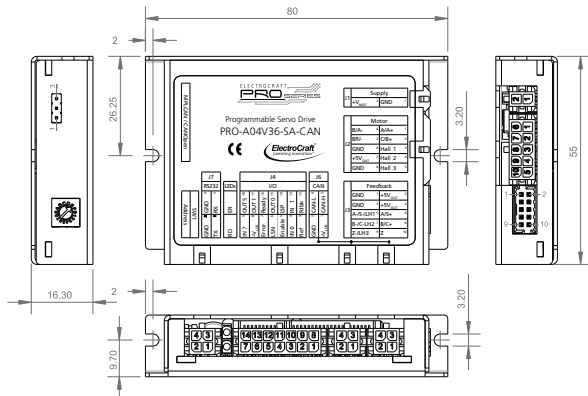

### Electrical Specifications

Maximum DC Supply Voltage: motor & logic		36	volt
Maximum continuous current	Peak of sine	4	amp
	RMS	2.8	amp
Peak current (2.4 sec. max.)	Peak of sine	10	amp
	RMS	7.1	amp
Nominal switching frequency		20 – 60	kHz

### Input

Logic Supply Input (+V <sub>LOG</sub> )		Min.	Typ.	Max.	Units
Supply Voltage	Nominal values	7		36	V <sub>DC</sub>
	Absolute maximum values, drive operating but outside guaranteed parameters	4.9		40	V <sub>DC</sub>
	Absolute maximum values, continuous	-0.7		42	V <sub>DC</sub>
	Absolute maximum values, surge (duration ≤ 10ms) <sup>†</sup>	-1		+45	V
Supply Current	+V <sub>LOG</sub> = 7V		125	300	mA
	+V <sub>LOG</sub> = 12V		80	200	
	+V <sub>LOG</sub> = 24V		50	125	
	+V <sub>LOG</sub> = 40V		40	100	
Motor Supply Input (+V <sub>MOT</sub> )		Min.	Typ.	Max.	Units
Supply Voltage	Nominal values	9		36	V <sub>DC</sub>
	Absolute maximum values, drive operating but outside guaranteed parameters	8.5		40	V <sub>DC</sub>
	Absolute maximum values, continuous	-0.7		42	V <sub>DC</sub>
	Absolute maximum values, surge (duration ≤ 10ms) <sup>†</sup>	-1		+45	V
Supply Current	Idle		1	5	mA
	Operating	-10	±4	+10	A
	Absolute maximum value, short-circuit condition (duration ≤ 10ms) <sup>†</sup>			15	A

### Output

Motor Outputs (A/A+, B/A-, C/B+, BR/B-)		Min.	Typ.	Max.	Units
Nominal output current, continuous	DC brushed, steppers and BLDC motors with Hall-based trapezoidal control			4	A
	Brushless motors with sinusoidal control (sinusoidal amplitude RMS value)			4	
	Brushless motors with sinusoidal control (sinusoidal effective RMS value)			2.82	
Motor output current, peak	maximum 2.5s	-10		+10	A
Short-circuit protection threshold	measurement range		±13	±15	A
Short-circuit protection delay		5	10		µs
On-state voltage drop	Nominal output current; including typical mating connector contact resistance		±0.3	±0.5	V
Off-state leakage current			±0.5	±1	mA
Motor inductance (phase to phase)	Recommended value, for current ripple max. ±5% of full range; +V <sub>MOT</sub> = 36 V	F <sub>PWM</sub>			µH
		20 kHz	250		
		40 kHz	120		
		60 kHz	90		

**PRO-A08V48: PRO Series** | Programmable Servo Drive



**Drive Model Example**

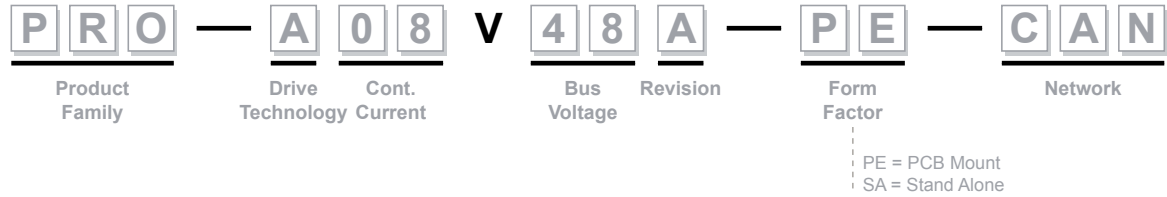

**PCB Mount PRO-A08V48x-PE-CAN Outline Drawing**

Model	A	B	C	Weight oz (g)
	Length in (mm)	Width in (mm)	Height in (mm)	
PRO-A08V48A-PE-CAN	2.2 (56)	1.73 (48.1)	0.27 (8.9)	0.56 (16)

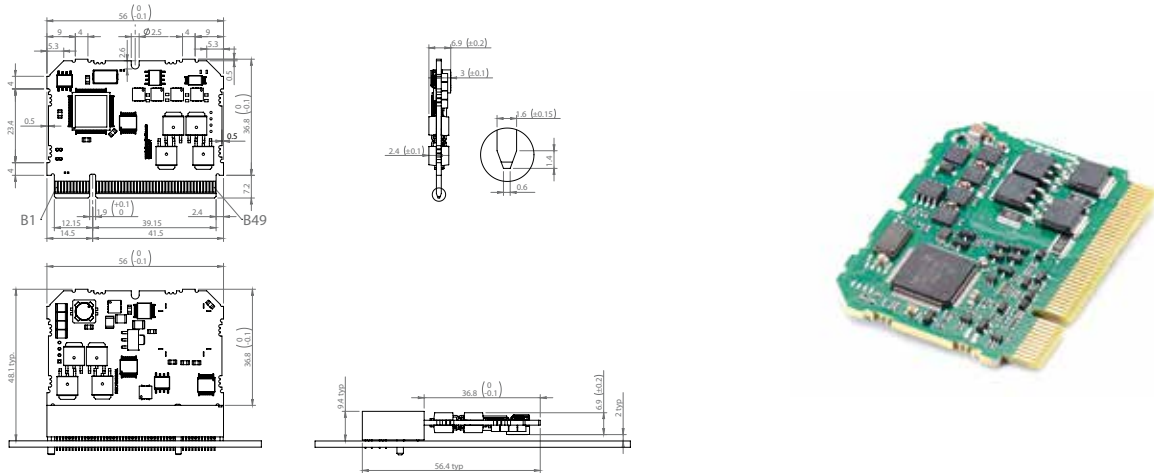

**Stand-alone PRO-A08V48x-SA-CAN Outline Drawing**

Model	A	B	C	Weight oz (g)
	Length in (mm)	Width in (mm)	Height in (mm)	
PRO-A08V48A-SA-CAN	3.49 (95)	2.85 (79)	0.65 (19.5)	3.9 (110)

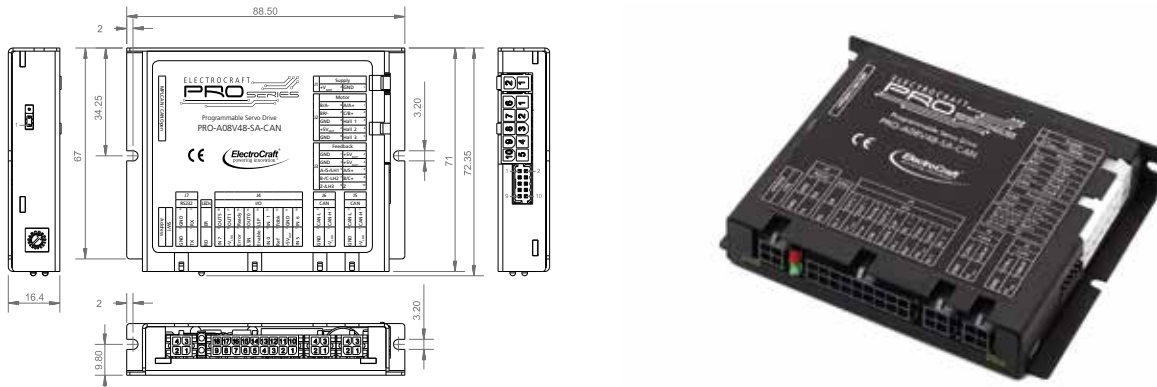



Electrical Specifications					
Maximum DC Supply Voltage	Motor	48	volt		
	Logic	36	volt		
Maximum continuous current	Peak of sine	8	amp		
	RMS	5.7	amp		
Peak current (2.4 sec. max.)	Peak of sine	20	amp		
	RMS	14.1	amp		
Nominal switching frequency		20 – 60	kHz		
Input					
Logic Supply Input (+V <sub>LOG</sub> )		Min.	Typ.	Max.	Units
Supply Voltage	Nominal values	9		36	V <sub>DC</sub>
	Absolute maximum values, drive operating but outside guaranteed parameters	8		40	V <sub>DC</sub>
	Absolute maximum values, continuous	-0.6		42	V <sub>DC</sub>
	Absolute maximum values, surge (duration ≤ 10ms) <sup>†</sup>	-1		+45	V
Supply Current	+V <sub>LOG</sub> = 7V		125	320	mA
	+V <sub>LOG</sub> = 12V		80	220	
	+V <sub>LOG</sub> = 24V		50	145	
	+V <sub>LOG</sub> = 40V		40	120	
Motor Supply Input (+V <sub>MOT</sub> )		Min.	Typ.	Max.	Units
Supply Voltage	Nominal values	11		50	V <sub>DC</sub>
	Absolute maximum values, drive operating but outside guaranteed parameters	9		52	V <sub>DC</sub>
	Absolute maximum values, continuous	-0.6		54	V <sub>DC</sub>
	Absolute maximum values, surge (duration ≤ 10ms) <sup>†</sup>	-1		+57	V
Supply Current	Idle		1	5	mA
	Operating	-20	±8	+20	A
	Absolute maximum value, short-circuit condition (duration ≤ 10ms) <sup>†</sup>			26	A
Output					
Motor Outputs (A/A+, B/A-, C/B+, BR/B-)		Min.	Typ.	Max.	Units
Nominal output current, continuous	DC brushed, steppers and BLDC motors with Hall-based trapezoidal control			8	A
	Brushless motors with sinusoidal control (sinusoidal amplitude RMS value)			8	
	Brushless motors with sinusoidal control (sinusoidal effective RMS value)			5.66	
Motor output current, peak	maximum 2.5s	-20		+20	A
Short-circuit protection threshold	measurement range		±26	±30	A
Short-circuit protection delay		5	10		μS
On-state voltage drop	Nominal output current; including typical mating connector contact resistance		±0.3	±0.5	V
Off-state leakage current			±0.5	±1	mA
Motor inductance (phase to phase)	Recommended value, for current ripple max. ±5% of full range; +V <sub>MOT</sub> = 36 V	F <sub>PWM</sub>			μH
		20 kHz	250		
		40 kHz	120		
		60 kHz	90		



## CONNECTION DIAGRAMS

These diagrams show the unipolar and bipolar switching sequence.

The direction of the rotation is viewed from the lead end.



CW Rotation (Lead End) ↓

Step	A	A'	B	B'
1	-		-	
2	-			-
3		-		-
4		-	-	

↑ CCW Rotation (Lead End)

2 Phase On

↓

1	-		-	
2	-			
3	-			-
4				-
5		-		-
6		-		
7		-	-	
8			-	

↑

Half Step

CW Rotation (Lead End) ↓

Step	A	A'	B	B'
1	+	-	+	-
2	+	-	-	+
3	-	+	-	+
4	-	+	+	-

↑ CCW Rotation (Lead End)

2 Phase On

↓

1	+	-	+	-
2	+	-	-	-
3	+	-	-	+
4	-	-	-	+
5	-	+	-	+
6	-	+	-	-
7	-	+	+	-
8	-	-	+	-

↑

Half Step

## Unipolar Configurations

To Fit Your Exact Application

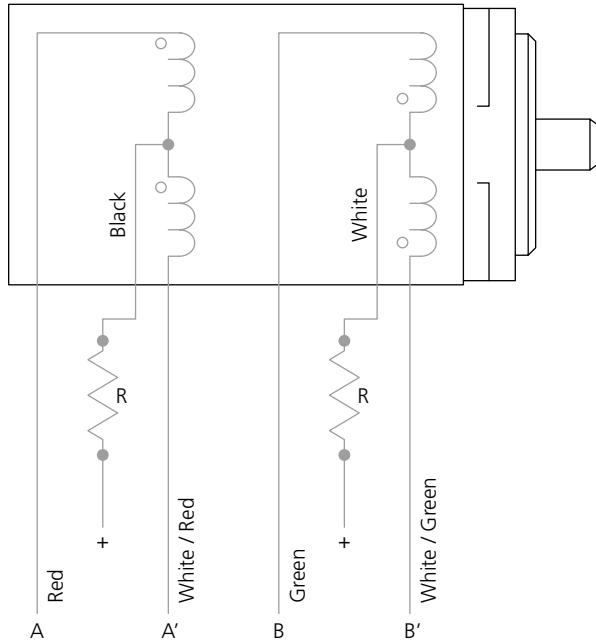

## Bipolar Configurations

These optional connections are also available. Please contact the factory for more information.

Bipolar (4 Leads)

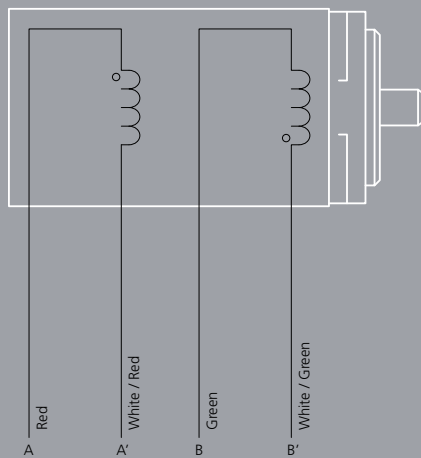

Bipolar Series

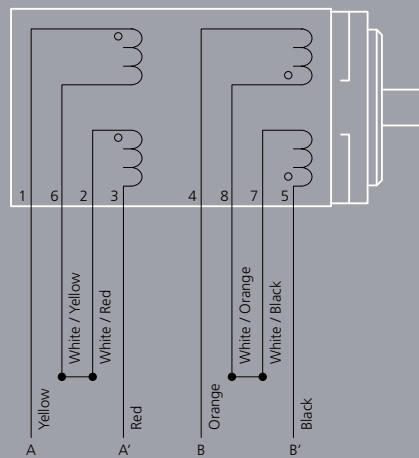

Bipolar Parallel

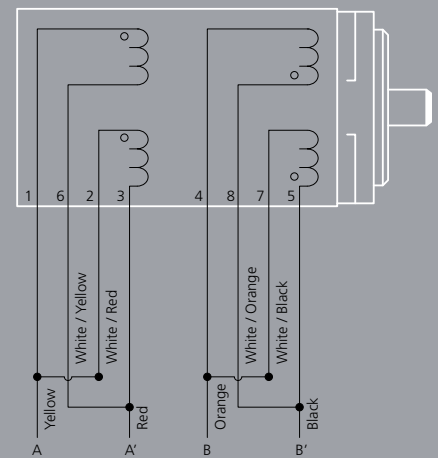



## GO FIGURE.

Customize your options ...

To easily find a motor / motion system that best meets your needs:

- Step 1: Select a base technology
- Step 2: Select a model type & features
- Step 3: Select a performance
- Step 4: Select an electrical winding
- Step 5: Select any options & accessories



Easily build your own motor at  
[www.configureamotor.com](http://www.configureamotor.com)

## Build Your Own ElectroCraft Motor To Fit Your Exact Application

For the past 60 years, the global team at ElectroCraft has helped engineers like you translate innovative ideas into reality. To build on that legacy, we created this Build-Your-Own ElectroCraft Motor web tool to get you started with our technology.



A web configuration tool from ElectroCraft ... Go Figure!  
**Your Genius. Our Drive.**

## System Matrix – Matching Motor and Drive Combinations

	Motor Series		Drive Models			
	Motor P/N		Bipolar Stepper		PRO Series	
	Imperial	Metric	SA4505	SA4510	PRO-A04V36	PRO-A08V48
TorquePower - TP	TP23-150A10		●		●	
	TP23-150A20		●		●	
	TP23-150A30		●			●
	TP23-150A40		●			●
	TP23-210A20		●		●	
	TP23-210A30		●			●
	TP23-210A40			●		●
	TP23-48A10		●		●	
	TP23-48A20		●		●	
	TP23-48A30		●		●	
	TP23-48A40			●		●
	TP23-72A10				●	●
	TP23-72A20				●	●
	TP23-72A30					●
	TP23-72A40				●	●
	TP34-235A20		●			●
	TP34-235A30		●			●
	TP34-235A40				●	●
	TP34-235A60				●	●
	TP34-420A20		●			●
	TP34-420A30		●			●
	TP34-420A40				●	●
	TP34-420A60				●	●
	TP34-620A20		●			●
	TP34-620A30		●			●
	TP34-620A40				●	●
	TP34-620A60				●	●
	TP42-1440A20		●			●
	TP42-1440A30		●			●
	TP42-1440A50				●	●
	TP42-2100A20		●			●
	TP42-2100A30		●			●
TP42-2100A50				●	●	
TP42-810A20		●			●	
TP42-810A30		●			●	
TP42-810A50				●	●	

	Motor Series		Drive Models				
	Motor P/N		Bipolar Stepper		PRO Series		
	Imperial	Metric	SA4505	SA4510	PRO-A04V36	PRO-A08V48	
TorquePower Plus - TPP		TPP11M-10A10	●		●		
		TPP11M-10A15	●		●		
		TPP11M-10A05	●		●		
		TPP11M-14A10	●		●		
		TPP11M-14A15	●		●		
		TPP11M-14A05	●		●		
		TPP11M-18A10	●		●		
		TPP11M-18A15	●		●		
		TPP11M-18A05	●		●		
		TPP17-29A10	TPP17M-21A10	●		●	
		TPP17-29A15	TPP17M-21A15	●		●	
		TPP17-29A20	TPP17M-21A20	●		●	
		TPP17-47A10	TPP17M-33A10	●		●	
		TPP17-47A15	TPP17M-33A15	●		●	
		TPP17-47A20	TPP17M-33A20	●		●	
		TPP17-58A10	TPP17M-41A10	●		●	
		TPP17-58A15	TPP17M-41A15	●		●	
		TPP17-58A20	TPP17M-41A20	●		●	
		TPP23-150A10	TPP23M-106A10	●		●	
		TPP23-150A20	TPP23M-106A20	●		●	
		TPP23-150A30	TPP23M-106A30	●			●
		TPP23-240A10	TPP23M-170A10	●		●	
		TPP23-240A20	TPP23M-170A20	●		●	
		TPP23-240A30	TPP23M-170A30	●			●
		TPP23-90A10	TPP23M-64A10	●		●	
		TPP23-90A20	TPP23M-64A20	●		●	
		TPP23-90A30	TPP23M-64A30	●			●
		TPP34-1190A20	TPP34M-840A20	●		●	
		TPP34-1190A30	TPP34M-840A30	●			●
		TPP34-1190A50	TPP34M-840A50		●		●
		TPP34-396A20	TPP34M-286A20	●		●	
		TPP34-396A30	TPP34M-286A30	●			●
	TPP34-396A50	TPP34M-286A50		●	●		
	TPP34-793A20	TPP34M-563A20	●		●		
	TPP34-793A30	TPP34M-563A30	●			●	
	TPP34-793A50	TPP34M-563A50		●	●		

TorquePower Enhanced - TPE	TPPE17-45A10	TPE17M-32A10	●		●	
	TPPE17-45A15	TPE17M-32A15	●		●	
	TPPE17-45A20	TPE17M-32A20	●		●	
	TPPE17-63A10	TPE17M-44A10	●		●	
	TPPE17-63A15	TPE17M-44A15	●		●	
	TPPE17-63A20	TPE17M-44A20	●		●	
	TPPE17-78A10	TPE17M-55A10	●		●	
	TPPE17-78A15	TPE17M-55A15	●		●	
TPPE17-78A20	TPE17M-55A20	●		●		



*Still need help?*  
 Easily build your own motor at  
[www.configureamotor.com](http://www.configureamotor.com)



*Don't see exactly what you need?*  
 Have ElectroCraft build you a  
 custom winding, stack length or  
 fully customized motor... that's  
 our specialty!



## Other Products available from ElectroCraft:

- CompletePower™ I Motion Control
- RapidPower™ I BLDC
- AxialPower™ I Linear Actuator
- DirectPower™ I PMDC
- MobilePower™ I Transmissions
- SolidPower™ Plus I Housed AC
- SurePower™ I C-Frame AC
- PRO Series I Motion Control



### CompletePower™ I Drives



With meticulous engineering and advanced electronics, our CompletePower speed controls and servo drives offer reliability and precision servo motion control. From sensitive medical dosing systems to rugged professional power tools, our CompletePower devices can handle a wide variety of applications.

### TorquePower™ I Steppers



With non-cumulative position accuracies as low as  $\pm 3\%$ , the precision of our TorquePower motor is matched only by the dependability of its performance. Bi-directional operation and enclosed, permanently lubricated ball bearings provide long-lasting, smooth operation.

### PRO Series I Drives



The PRO Series Programmable Servo Drive provides a new design concept offering a cost effective, compact and modular solution for the control of rotary or linear stepper, brushless or PMDC brush motors of powers up to 385W, with up to 48V nominal voltage and 5.7A (RMS) continuous current.

**RapidPower™ | BLDC**



Our BLDC motors provide the rapid acceleration and consistent speed needed for applications from centrifuges to x-y positioning systems. The RapidPower product line ensures a steady operation at any speed by utilizing sealed ball bearings and reduced torque ripple from skewed magnetization.

**AxialPower™ | Linear Actuator**



Based on modified hybrid steppers, PMDC, and BLDC motors, our family of AxialPower linear actuators are built to last. Our unique approach to linear motion with low-friction, polymer rotating nuts and stainless steel leadscrews provides high force and linear precision in the smallest packages available.

**DirectPower™ | PMDC**



Dynamically balanced armatures and precision ball bearings ensure that the DirectPower line maintains its characteristically smooth performance. This durable, totally enclosed, non-ventilated (TENV) motor is available in a broad product line from lower cost, general purpose options to high performance PMDC servo motors.

**MobilePower™ | Transmissions**



With a choice of output ratios, our MobilePower line of products helps power battery-operated vehicles from wheelchairs to lift trucks. And, to increase durability and decrease noise levels, the robust all metallic gears are hobbed to a precision AGMA 9-Class.

**SolidPower™ Plus | Housed AC**



High starting torques and stator windings matched to your application ensure the SolidPower product provides lasting performance. The dynamically balanced, skewed rotor bars and precision-machined fits keep vibration levels at a minimum.

**SurePower™ | C-Frame AC**



Our AC shaded-pole motor, the SurePower product, can be utilized for a wide range of air-moving applications – perfect for the rigors of refrigeration and commercial food equipment applications.

## To build your own motor, choose the:

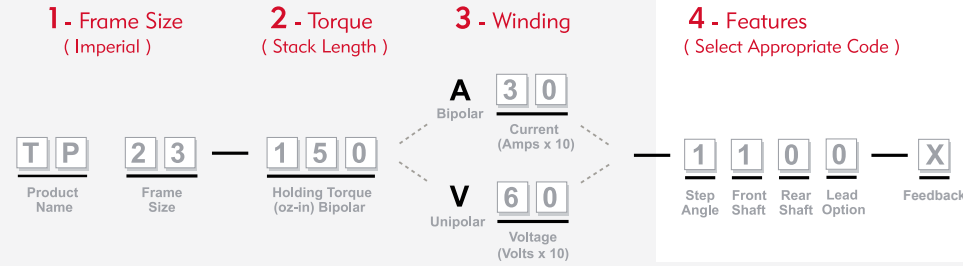

### Step 4: Stepper Motor Features

Step Angles	Front Shaft	Rear Shaft	Lead Option	Feedback Options
0 = 0.9°	0 = round shaft	0 = none	0 = flying leads	X = none
1 = 1.8°	1 = flat shaft	1 = standard shaft	1 = connector	B = 400 Line Differential Encoder
Option 0 only available on TP17(M) and TPP23(M)	2 = key seat		2 = integral connector only	D = 1000 Line Differential Encoder
	Option 2 only available on shaft diameters 0.3150 inches (8mm) and larger		Option 2 only available on TPP11M	H = 400 Line Single-Ended Encoder
				K = 1000 Line Single-Ended Encoder

Motor Size	Encoder	Line Count	Motor Size	Encoder	Line Count	Motor Size	Encoder	Line Count
TPP11M	B	400 Line Differential	TPP17 TPE17	B	400 Line Differential	TP23 TP34 TP42 TPP23 TPP34	B	400 Line Differential
	H	400 Line Single-Ended		D	1000 Line Differential		D	1000 Line Differential
				H	400 Line Single-Ended		H	400 Line Single-Ended
				K	1000 Line Single-Ended		K	1000 Line Single-Ended

SHOWN AS ASSEMBLED UNIT

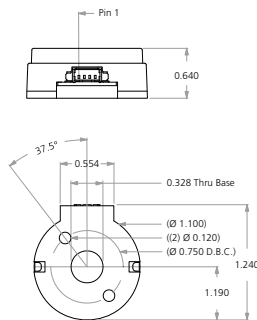

SHOWN AS ASSEMBLED UNIT

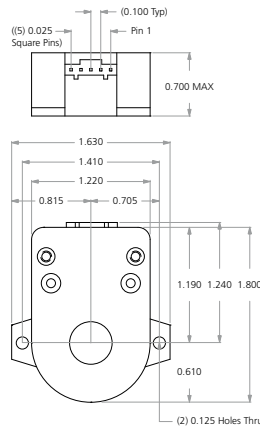



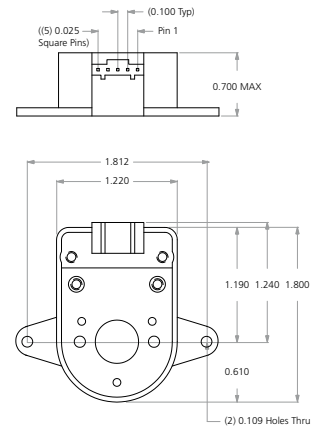



SHOWN AS ASSEMBLED UNIT



Pin Number	Parameter	Lead-wire color	Supply Voltage	Pin Number	Parameter	Lead-wire color	Supply Voltage	Pin Number	Parameter	Lead-wire color	Supply Voltage
TPP11M Single-Ended Encoder				TP23/34/42, TPP17/23/34 Single-Ended Encoder				TP23/34/42, TPP17/23/34 Differential Encoder			
Pin 1	+ 5 VDC	ORG	5VDC ± 0.5	Pin 1	Ground	BRN	5VDC ± 0.5	Pin 1	Ground	NC	5VDC ± 0.5
Pin 2	CH A	BLU		Pin 2	CH Z	PUR		Pin 2	Ground	GRN/WHT	
Pin 3	Ground	BRN		Pin 3	CH A	BLU		Pin 3	Ch Z -	WHT/ORG	
Pin 4	CH B	YEL		Pin 4	+ 5 VDC	ORG		Pin 4	CH Z+	ORG/WHT	
			Pin 5	CH B	YEL	Pin 5		CH A-	WHT/BLU		
						Pin 6	CH A+	BLU/WHT			
						Pin 7	+ 5 VDC	WHT/GRN			
						Pin 8	+ 5 VDC	NC			
						Pin 9	CH B-	WHT/BRN			
						Pin 10	CH B+	BRN/WHT			
<b>Mating Connector</b>	Connector: Molex 51021-0400 Pins: Molex 50079-8100			<b>Mating Connector</b>	Connector: Molex 14-56-2052 Pins: Connector Includes Pins			<b>Mating Connector</b>	Connector: Molex 15-04-5104 Pins: Molex 14-60-0058		



Drive Accessories					
Patch Cable					
	P/N	50cm	100cm	200cm	300cm
	Red	CA2005	CA2010	CA2020	CA2030
	Yellow	CA4005	CA4010	CA4020	CA4030
	Gray	CA8005	CA8010	CA8020	CA8030
Passive heatsink					
	Passive heatsink optimized for drives: SA45				P/N HA3008
fanned heatsink					
	One fan heatsink optimized for drives (fan is 1 x 24 VDC, .8 W): SA45				P/N HA3018
fanned heatsink					
	Two fan heatsink optimized for drives (fans are 2 x 24 VDC, .8 W): SA45				P/N HA3028
Choke module					
	Choke module optimized for brushless drives. Inductance: IA2100 = 2x50 $\mu$ H; IA2101 = 2x100 $\mu$ H Nominal current: 10 A				P/N IA310x
DIN Rail mounting kit					
	DIN Rail mounting kit for units: SA45				P/N MA0025
Break Out Board					
	Break Out Board for: SA45				P/N WA2509